



MANGO POWER M User Manual

The specifications and descriptions contained herein were precise and correct upon printing. However, given the goal of continuous improvement of MANGO POWER products, we reserve the right to modify select product specifications at any time without prior notice. The images herein are for illustration only. In case of any errors or omissions, please contact us at support@mangopower.com.

The MANGO POWER M provides a limited warranty, validity of which depends on the connection between the MANGO POWER App and the Internet. To fully utilize the 10-year limited warranty, the MANGO POWER M must remain connected to a reliable internet source to allow automatic remote firmware upgrades. If a connection to the Internet is not established or if the device is disconnected from the Internet for more than 45 days the warranty can be limited to 5 years only.

Safety Instructions

Please keep and properly safeguard these important safety instructions. Installation and maintenance of MANGO POWER M requires knowledge of high voltage power, and hence can only be carried out by professional installation personnel. MANGO POWER should not be held responsible for any personal injury or property loss arising from attempts to repair the device or equipment by unqualified personnel or failure to comply with these instructions. These warnings and precautions must be followed when using the MANGO POWER M.

 Warning	Used to give warnings on issues that, if not avoided, might lead to personal injury or death.
 Caution	Indicates a hazard that, if not avoided, might lead to equipment damage.
 Note	Indicates steps or tips that are important to securing the best results but have nothing to do with safety or damage.

Warning

- Please read through the entire document prior to installation or use of the MANGO POWER M. Failure to do so or refusing to follow any instructions or warnings herein might lead to electric shocks, severe injury or even death. It may also damage the MANGO POWER M device to the extent that may stop working.
- The batteries might present the risk of electric shock, fire, or venting explosions when handled improperly. Please take the applicable precautions.
- Installation of the MANGO POWER M must be carried out by professionals who are trained on handling high voltage power.
- For the safe handling of the MANGO POWER M model, a team lifting approach is recommended.
- The MANGO POWER M should only be used in compliance with its instructions.
- If the MANGO POWER M is subject to defects, cracks, damage, etc. or is not operable, please do not use it.
- Please switch off the inverter and disconnect AC and DC breakers before commencing wiring.
- Do not attempt to open, dismantle, repair, modify or alter the MANGO POWER M.
- Maintenance of the MANGO POWER M is off limits to end-users. Please contact MANGO POWER after-sales if you need maintenance.
- Please handle the MANGO POWER M with care to protect it and its components from any damage.
- Do not bump into, drag, pull, or step on the MANGO POWER M.
- Do not place the MANGO POWER M under any major force. Please maintain the shipment packaging of the MANGO POWER M components until they are installed to prevent any damage.
- Do not insert any external objects into any parts of the MANGO POWER M.
- Do not have the MANGO POWER M or its components exposed directly to a flame.
- Do not have the MANGO POWER M installed in the proximity of a heating device. Do not have the MANGO POWER M or any of its components immersed in water or other liquids.
- Operating or storing the MANGO POWER M at a temperature beyond the specified range might damage it.

Caution

- Do not clean the MANGO POWER M with any detergent or expose it to any flammable or irritating chemical substances or vapors.
- Do not apply a coating on any parts of the MANGO POWER M - including internal or external components such as the enclosure.
- When installing the MANGO POWER M in a garage or near a vehicle, please ensure that it is placed outside of driving paths
- If possible, please mount the device to a wall or at a height above any bumpers.
- The M Hybrid Inverter is equipped with a durable enclosure for added protection. To prevent any damage, we kindly request that you place the M Hybrid Inverter on its back before lifting it onto the wall-mounted support. This precautionary measure ensures the safe and secure installation of the inverter while preserving the integrity of its enclosure.
- To ensure the proper functioning and safety of the MANGO POWER M, it is important to make sure that no water source, including downspouts, taps, pressure washers, or sprinklers, is located above or in the vicinity of the unit
- Make sure that the MANGO POWER M does not accumulate snow on top of it or in its vicinity.

TABLE OF CONTENTS

1	Product introduction	01
2	Product Parameters	01
3	What's In The Box	05
4	Installation Tools And Materials	07
4.1	Installation Tools	07
4.2	Installation Materials	07
5	Component Overview	07
5.1	M Hybrid Inverter 12K	07
5.2	M Battery 5kWh	09
5.3	M Cabinet	10
6	Instructions on Installation	10
7	Wall Mounting	11
7.1	M Hybrid Inverter 12k Wall Mounting	12
7.2	M Cabinet Wall Mounting	13
7.3	Installation Of M Battery 5kwh And M Cabinet	14
8	Wiring	15
8.1	Overview Of System Wiring	16
8.2	M Hybrid Inverter 12k Wiring	16
8.2.1	PV Connection	17
8.2.2	M Cabinet Connection	18
8.2.3	Grid & Backup Load Connection	19
8.2.4	Generator System Connection	23
8.2.5	AC Coupling Connection	25
8.3	Connection Between M Battery 5kwh And M Cabinet	26
8.4	Connection Between M Hybrid Inverter 12kw And Multiple M Cabinets	28
8.4.1	M Hybrid Inverter Parallel System Connection	28
8.4.2	Wiring between a single M Hybrid Inverter and multiple M Cabinets	33
8.4.3	Wiring multiple M Hybrid Inverters to a single M Cabinet	35
8.4.4	Wiring between 10 M Hybrid Inverters and 40 M Cabinets	36
8.5	Direction On System Wiring Confirmation	36
9	Installation And Wiring Of M Smart Screen	37
10	Mango Power App	37
11	Operating Instructions	37
11.1	Work Modes And Functions	37

11.1.1 Self-Consumption Mode (Default)	37
11.1.2 Charge First Mode	38
11.1.3 AC Charge Mode	38
11.1.4 Peak Load Shifting Of Grid	39
11.1.5 Intelligent Loads	39
11.2 Pv Quick Shutdown	39
11.3 M Smart Screen	40
11.3.1 Check Info, Alarms, And Failure Logging	40
11.3.2 Parameter Settings	41
11.4 Start And Stop Inverters	44
11.4.1 Start Inverters	44
11.4.2 Stop Inverters	44
12 Troubleshooting And Maintenance	44
12.1 Regular Maintenance	44
12.2 M Battery Troubleshooting	45
12.2.1 Notes On Indicator Lamps:	45
12.2.2 Troubleshooting	45
12.3 Troubleshooting According To M Smart Screen	46
12.3.1 States Indicated By M Hybrid Inverter Leds	46
12.3.2 Faults Display On M Smart Screen	46
12.3.3 Alarms Displayed On M Smart Screen	47
12.4 Replacement Of Inverter Fan	49
13 Appendix: Technical Data	49
13.1 Remote Start-Up/Stop Of Inverter And Alteration Of Parameter Settings	49
13.2 Set Parameters As Per Rule21	50
13.2.1 Enter Service Setting	50
13.2.2 High Voltage And Low Voltage Trip	50
13.2.3 High Frequency And Low Frequency Trip	50
13.2.4 Specified Power Factor (Spf)	51
13.2.5 Voltage / Var Mode (Q(V))	51
13.2.6 Active Power-Reactive Power Mode (Q(P))	51
13.2.7 Constant Reactive Power Mode	52
13.2.8 Frequency-Watt (Fw)	52
13.2.9 Voltage-Watt (Vw)	53
13.2.10 Active Power Limit Mode	53
13.3 Test Parameter Tolerances	53

1 Product introduction

MANGO POWER M is a universal all-in-one intelligent power system compatible with AC-coupled solar power system and DC coupling with new solar power modules. It can fulfill the on/off grid needs and provide one-stop solutions to household backup power. MANGO POWER M is integrated with a 12 kW hybrid inverter and supports current input from photovoltaics, generators, and the grid. Having the capacity in a range of 15 ~ 80 kWh, the world-leading lithium iron phosphate (LFP) batteries provided by CATL are safe and durable and realize efficient power distribution through intelligent load control to fulfill all your backup power demands. In a commercial environment, you can superimpose up to 10 inverters to reach a total power of 120 kW. Through battery expansion, the system can support 100% power independency.

2 Product Parameters





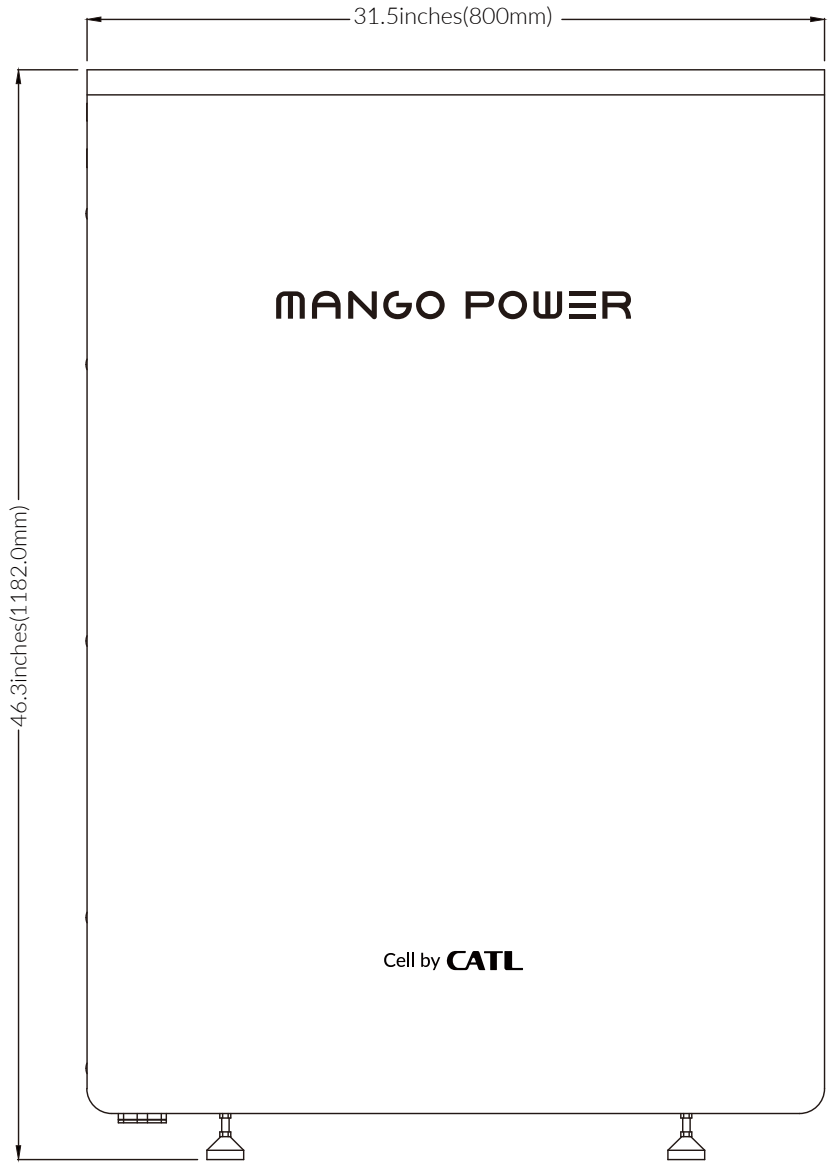
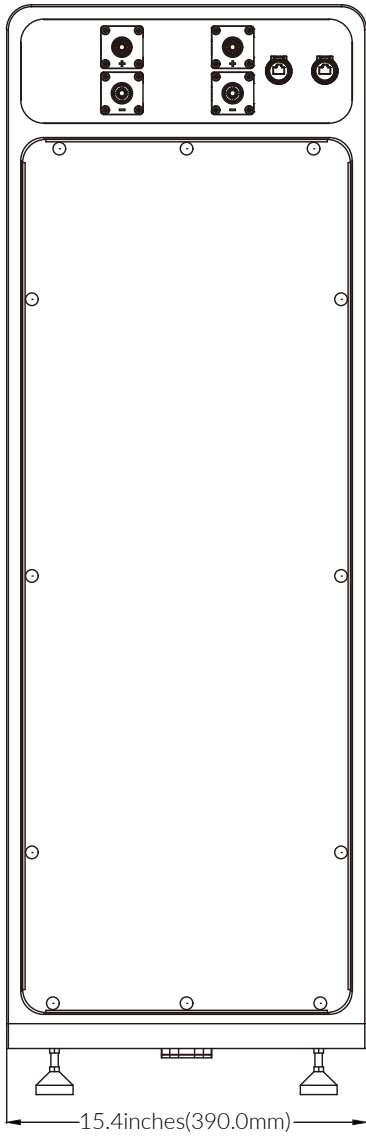

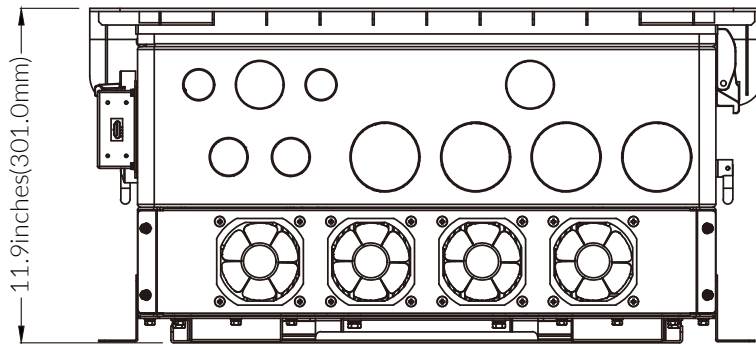
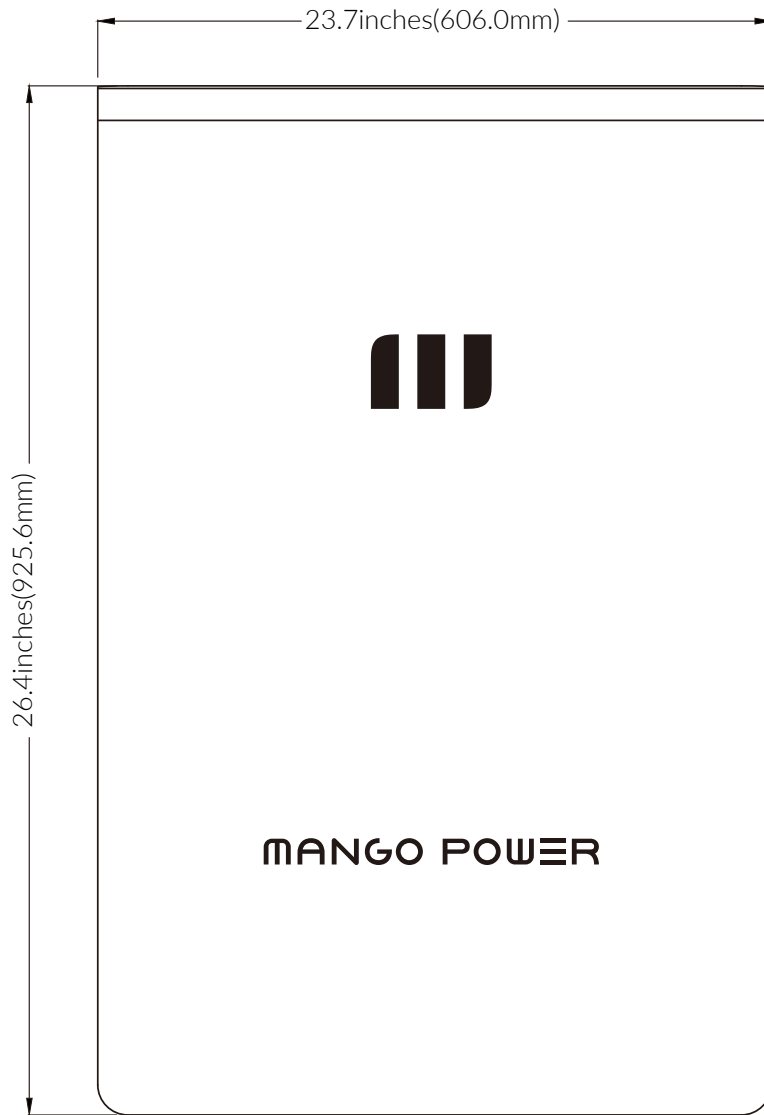









M Hybrid Inverter 12kW Parameters	
Weight	119.9lbs (54.4kg)
Size	36.4x23.7x11.9in(925.6*606*301mm)
AC - On-Grid Power Parameters	
Maximum continuous AC output power	12000VA/240V & 10400VA/208V
Peak power	24000VA 500ms
Grid-tied power factor (adjustable)	0.8leading~0.8lagging adjustable
Nominal AC output voltage	120V/240V/208V
Voltage range	180V~270V
Maximum continuous AC current	50A
Nominal frequency	60Hz
Extended frequency range	55~65Hz
Maximum AC output over current protection	75A
Max efficiency	97.5%(PV to grid) 94%(battery to grid)
THDI	<3%
Cooling	Low noise Fans
AC - Backup Output Power Parameters	
Maximum continuous AC output power	12000VA/240V & 10400VA/208V
Peak power	24000VA 500ms
Nominal AC output voltage	120V/240V/208V
Voltage range	180V~270V
Maximum continuous AC current	50A
Nominal frequency	60Hz
Extended frequency range	55~65Hz
Maximum AC output over current protection	75A
Max efficiency	97.5%(PV to grid) 94.0%(battery to grid)
THDV	<3%
Bypass grid switching time	<20ms
Maximum AC output over current	200A
DC-PV Parameters	
PV modules power	18000W
MPPT numbers	3 max power point trackers (two strings combined)
MPPT voltage range	120V~500V
Full power MPPT voltage range	230V~500V
Maximum input DC voltage	600V
Maximum input current	25/15/15A
Maximum DC input short circuit current	31/19/19A
MPPT efficiency	99.90%

M Smart Screen	
WiFi Dongle	2.4G connection, 802.11b/g/n
Connection	HDMI
Screen Size	4.3 inches
M Battery 5kWh Parameters	
Battery chemistry	World's best LFP battery powered by CATL
Capacity	From 15kWh/300Ah to 20Wh/400Ah with four M Battery packs
Battery DC voltage range	44V~60V
Max charging current	Super-fast continuous charging speed, up to 1C for battery pack. 250A for 15000Wh and 20000Wh
Max discharging current	250A (for at least 3 M Battery packs)
Roundtrip efficiency	97.00%
Weight	103.6lbs(47kg)
Size	22.9x5.2x15.2 inches (581x133x387mm)
Battery Working Temperature	Charging: 32°F~140°F(0°C~60°C) Discharging: -4°F~140°F(-20°C~60°C)
Life Span	6000 cycles (@25°C, +0.5C/-0.5C)
M Cabinet Parameters	
Environmental category/UV expose rating	NEMA Type 4X/IP65 outdoor
Capacity	From 1~4 M Battery packs
Weight	114.2lbs (51.8kg)
Size	31.5x15.4x46.3in (800x390x1182mm)
Cabinet installation	M-slide-a-way for easy installation
Features and Certification	
RSD/AFCI	PV rapid shut down integrated
Integrated disconnection	DC switch
Grid-following	Grid-tied
Grid-forming	Micro-grid
Certification	CA rule21 UL1741/IEEE1547/UL1973/UL1642/UL9540&UL9540A
Generator	Smart control by AGS (Auto Generator Start) 10800W for generator, 120V Maximum 90A
Home backup	Whole and partial home backup
Smart control	MANGO POWER App download from APP Store or Google Play
System design	AC coupled and DC coupled
Grid type	120V/240V/208V Split-phase L1,L2,N,PE (single phase)
Inverter Working Temperature	-13°F to 140°F>113°F derating (-25°C to 60°C>45°C derating)
Size	36.4x23.7x11.9in (925.6*606*301mm)
	for M Power Hybrid Inverter,
	31.5x15.4x46.3in (800x390x1182mm) for M Cabinet
Weight	119.9lbs (54.4kg) for M Power Hybrid Inverter, 103.6lbs (47kg) for M Battery,
	114.2lbs (51.8kg) for M Cabinet
Installation	Ground placed and slightly wall mounted
Noise	<50dB (Do not install Power M next to the wall of bedroom)
Environmental category/UV expose rating	NEMA type 4X/IP65 outdoor rated
Relative humidity	0%~100% (condensing)
Altitude	<2000m
Warranty	The product retains 70% of its available capacity within 6 months after the date of manufacture or 10 years after the date of completion of installation and commissioning

























3 What's in the Box

M Hybrid Inverter 12kW				
No.	Photo	Name	Number	Unit
1		M Hybrid Inverter (12kW)	1	pcs
2		CT	2	pcs
3		Wall-hung support	1	pcs
4		Fasteners for wall mounting	2	pcs
5		M8x80 expansion bolts	8	pcs
6		Expansion plugs	6	pcs
7		M3x10 hexagon combination screw	6	pcs
8		M5x10 combination screw	6	pcs
9		M5x32 self-tapping screw	6	pcs
10		M8x45 hexagon dovetail self-tapping screw	8	pcs
11		Key	2	pcs
12		Nylon locking nut	10	pcs
13		Communication cable	1	pcs
14		Paralleling communication cable	1	pcs
15		HDMI cable	1	pcs
16		waterproof stopper	2	pcs
17		M Smart Screen	1	pcs

M Battery 5kWh

1		Lithium iron phosphate battery cabinet	1	pcs
2		anode+ wire	1	pcs
3		cathode- wire	1	pcs
4		Communication cable	1	pcs
5		Ground wire	1	pcs
6		Type O terminal	1	pcs
7		M6x16 hexagon combination screw	2	pcs
8		Quality Certificate	1	pcs

M Cabinet

1		anode+ wire	2	pcs
2		cathode- wire	2	pcs
3		Hook	3	pcs
4		Hook cover	3	pcs
5		Hanger 1	1	pcs
6		Hanger 2	1	pcs
7		Expansion plugs	10	pcs
8		M5x32 self-tapping screw	10	pcs
9		M5x12 hexagon combination screw	8	pcs
10		RJ45 connector	1	pcs
11		Plug clip	14	pcs
12		Warning sign	1	pcs
13		User Manual	1	pcs

4 Installation Tools and Materials

4.1 Installation tools



Installation gloves



Safety goggles



Protective shoes



Drill



Phillips/Slotted screwdriver

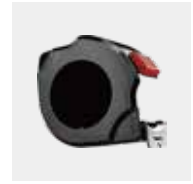

Tape measure



Marker pen

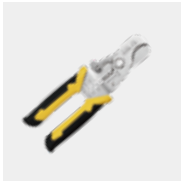

Crimping pliers

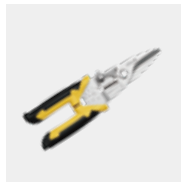

Cutting nippers



Adjustable wrench



Spirit level

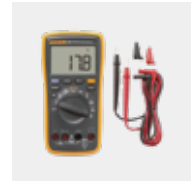

Multimeter

4.2 Installation Materials

Please prepare the following materials before installation: Waterproof, sturdy sleeves (steel pipes are recommended), sleeve connectors, sleeve clips, fireproofing clay, cables, and combiner box (this is required if you've purchased more than one M Cabinet and M Hybrid Inverter).

a. Sleeve: ID 1.5 inches (38.1mm) .

Sleeve connector: straight union 1.5inches (38.1mm).

b. Cables

PV panel connection cables: 8~10AWG (5~8mm²), min. voltage 600V.

Battery power cable: 2/0~3/0AWG (65~85 mm²), 125°C, min. voltage 600V.

Grid connection cable:

at 100 A, 3/0~2/0AWG (25~35mm²), min. voltage 600V;

at 200 A, 1/0~2/0AWG(55~70mm²), min. voltage 600V.

c. Combiner box: 240V/300A or 120V/600A or 208V/350A combining copper busbar.

5 Components Overview

5.1 M Hybrid Inverter 12kW

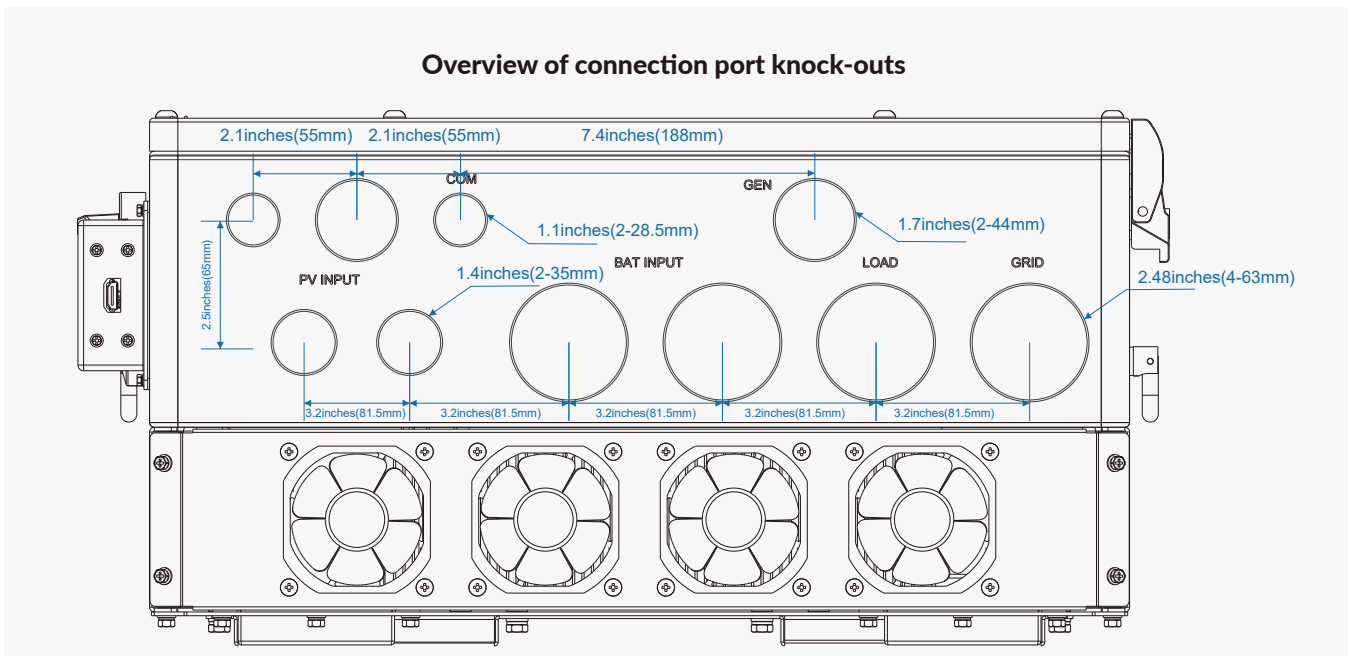

Overview of junction box

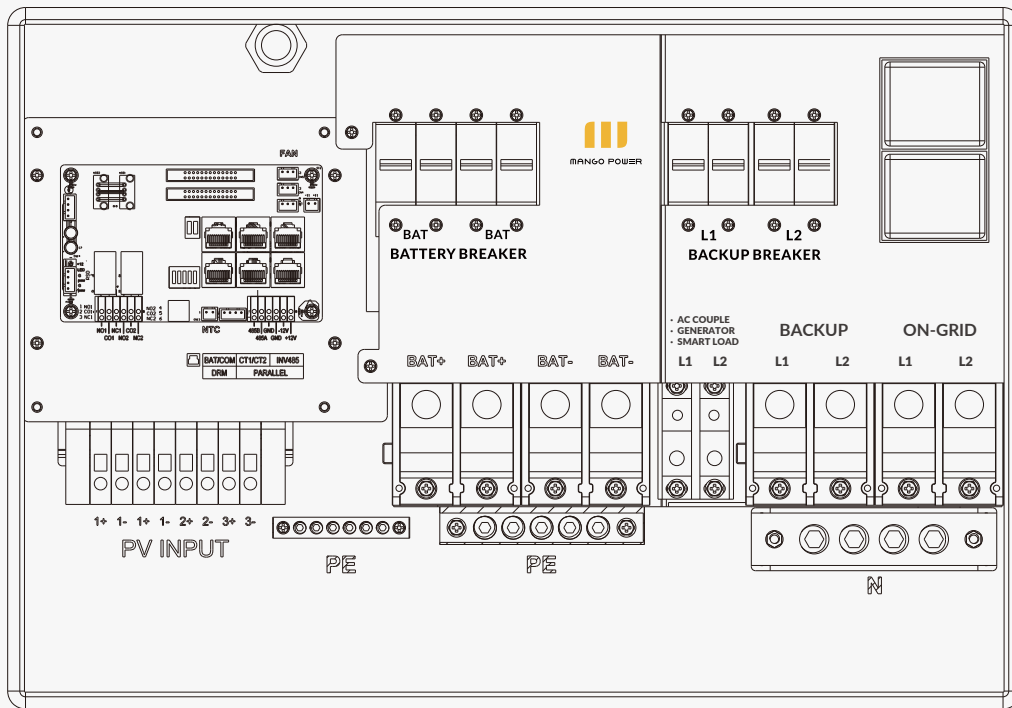

M Hybrid Inverter integrates with BACKUP Breaker and BATTERY Breaker, which are 200A and 2x200 A respectively.

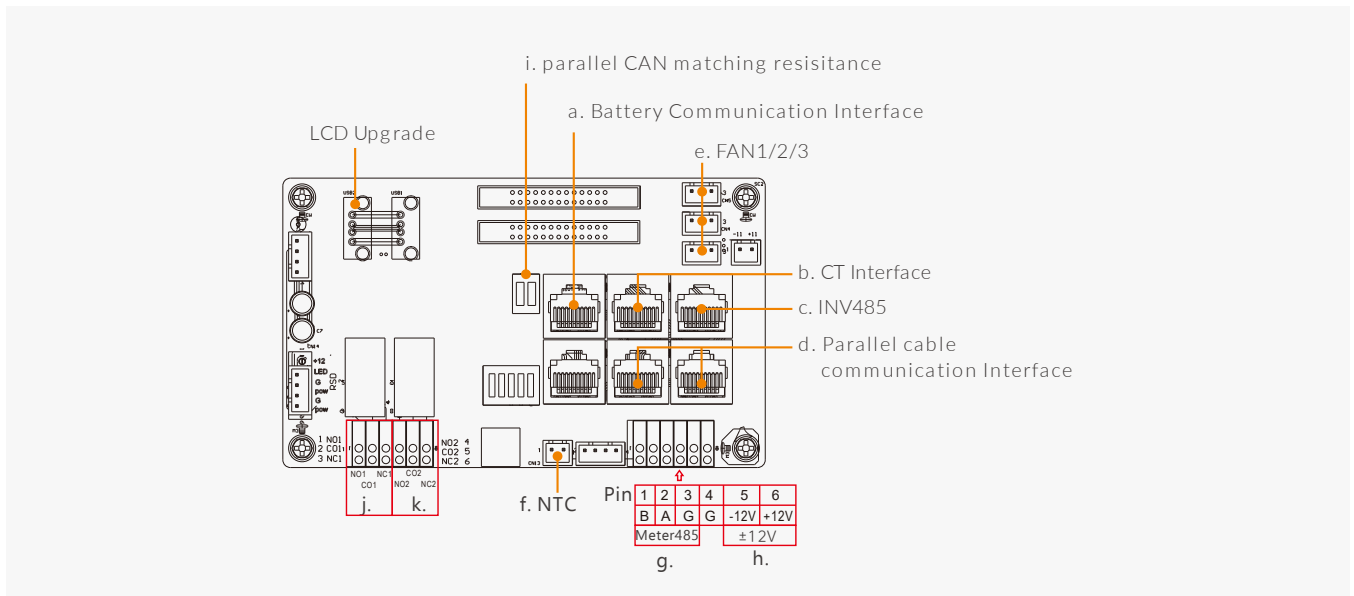

- a. Battery communication interface (CAN&RS485). See 8.2.2 for definitions of pins.
- b. CT interface: For CT connection information, see 7.3.3.
- c. INV 485: debugging port
- d. Parallel communication port. For parallel connection, see 7.3.5.
- e. Fan 1/2/3
- f. Temperature: Connection to lithium iron phosphate temperature sensor
- g. Meter 485B&485A: for meter communication.
- h. +12V: These 2 terminals are for connection to the external emergency switch.
- i. CAN matched resistor: Set this dial switch when inverters are parallel.
- j. GEN (NO/NC): Automatically started and connected by the generator.
- k. DRY (NO/NC): Reserved

5.2 M Battery 5kWh

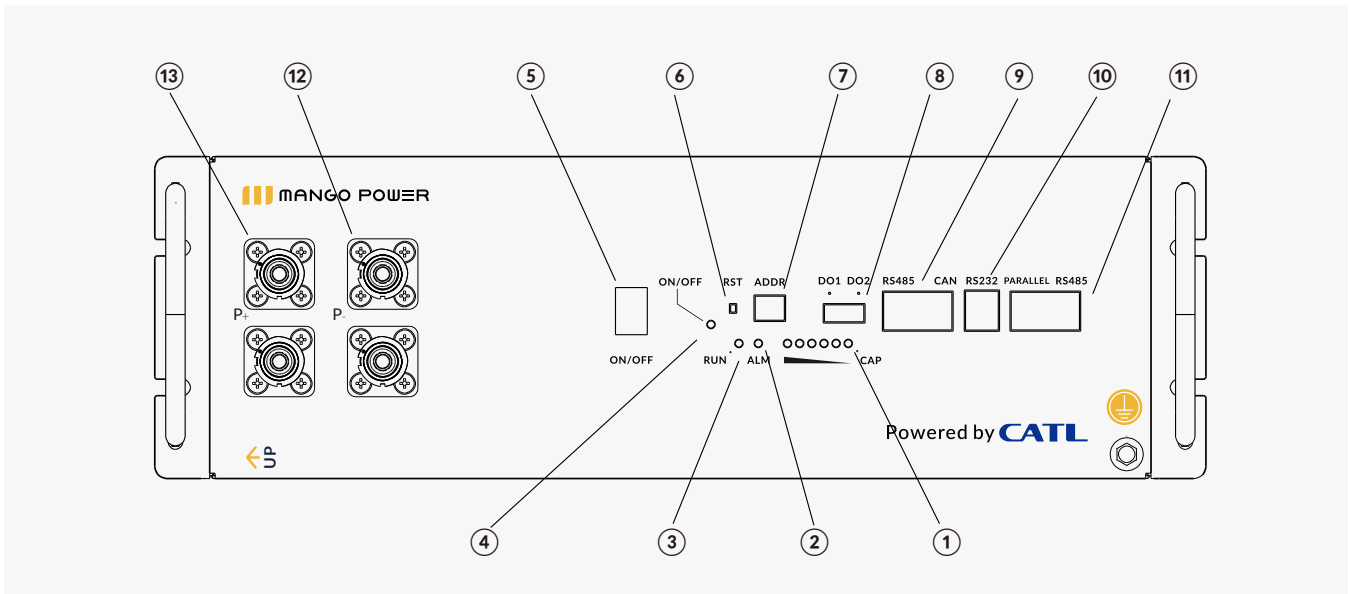

- ① Capacity indicator lamp: CAP lamp, 6 battery capacity indicator lamps. Each lamp indicates 16.6% of the capacity.
- ② Alarm indicator lamp: ALM lamp, red. This light goes on when the battery system incurs a fault.
- ② Running indicator lamp: RUN lamp, green. This light stays on during charging and flashes during discharging.
- ④ State indicator lamp: on/off lamp, green. This light goes on whenever the “On/Off” switch is pressed.
- ⑤ On/Off switch: The system begins its regular running or shutdown state.
- ⑥ Reset button: RST button, used to reset the system when an anomaly occurs.
- ⑦ DIP switch: ADDR switch, used to change the modules.
- ⑧ Dry contact: DO1 and DO2. Two options are reserved for dry contact output.
- ⑨ Primary computer communication: RS485, CAN, and PCS communication (one from two), 2 RJ45 interfaces.
- ⑩ Debugging port: RS232, used for debugging.
- ⑪ Parallel comm interface: Parallel RS485, parallel module communication, 2 RJ45 interfaces.
- ⑫ Battery anode+ connection: used to connect to the anode+ of the battery module.
- ⑬ Battery cathode- connection: used to connect to the cathode- of the battery module.

Note:

Notes on capacity indicator lamp:													
Status	Charging						Discharging						
Capacity indicator lamp	L6	L5	L4	L3	L2	L1	L6	L5	L4	L3	L2	L1	
SoC (%)	0~16.6%	Off	Off	Off	Off	Off	Flash 2	Off	Off	Off	Off	Off	On
	16.6~33.2%	Off	Off	Off	Off	Flash 2	On	Off	Off	Off	Off	Off	On
	33.2~49.8%	Off	Off	Off	Flash 2	On	On	Off	Off	Off	On	On	On
	49.8~66.4%	Off	Off	Flash 2	On	On	On	Off	Off	On	On	On	On
	66.4~83.0%	Off	Flash 2	On	On	On	On	Off	On	On	On	On	On
	83.0~100%	Flash 2	On	On	On	On	On	On	On	On	On	On	On
	Run lamp indicator	On						Flash (Flash 3)					

Notes on LED flashes		
Way of flashes	On	Off
Flash 1	0.25s	3.75s
Flash 2	0.5s	0.5s
Flash 3	0.5s	1.5s

5.3 M Cabinet

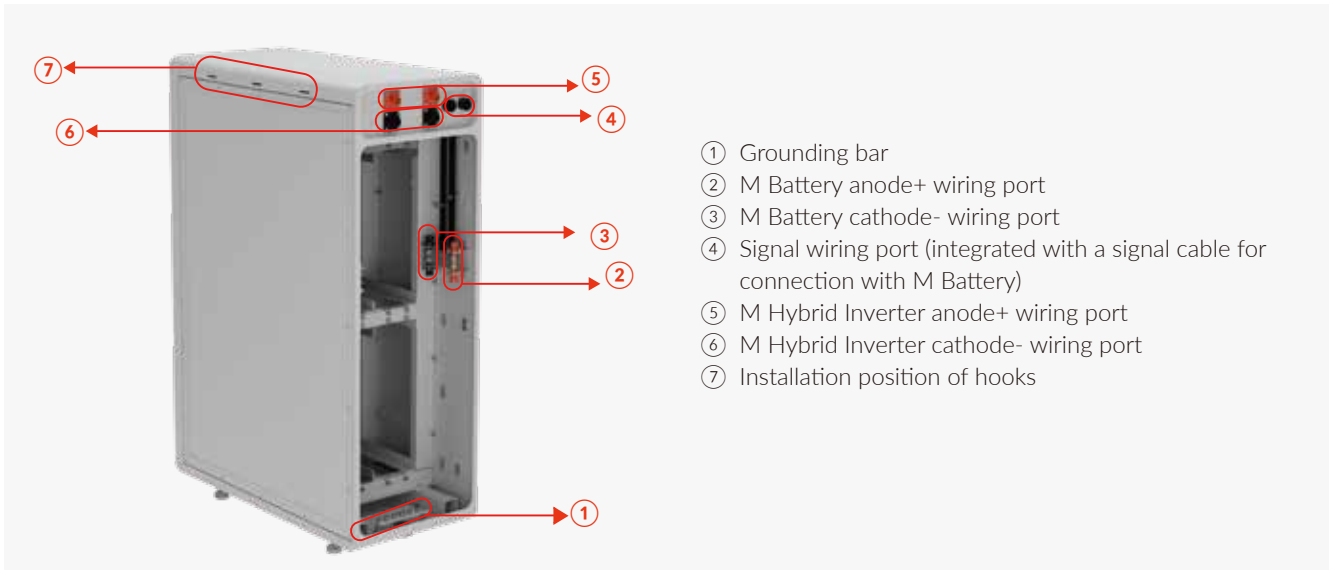

6 Instructions on Installation

The design and manufacturing of the MANGO POWER M are adapted to the applicable safety rules and the needs of its users. Prior to installation, you should decide on an appropriate position for the installation to be safely used. You must follow the instructions when installing and using the product.

Warning

- If possible, please mount the device to a wall or at a height above any bumpers.
- When installing the MANGO POWER M indoors within a residential area, the device should be placed in a shed or other annexes that are at least 60 inches (1,524 mm) away from the main residence. It should NOT be installed in living spaces - including but not limited to bathrooms, storerooms, passages, and entrance halls. Adhering to these guidelines ensures the safe and appropriate installation of the MANGO POWER M in an indoor residential setting.
- Do not install the product in a place subject to direct sunlight, rain or snow. The ambient temperature should fall into $\sim 10^{\circ}\text{C} \sim 45^{\circ}\text{C}$ ($14^{\circ}\text{F} \sim 113^{\circ}\text{F}$).
- M Hybrid Inverter is designed for wall-mounting only. The surface of mounting must be capable of bearing the weight of the product.
- Do not install the product horizontally or on a wall with an inclination over 10° . Do not mount it on an inclined surface.
- Read all instructions, precautions, and warnings of the MANGO POWER M and other relevant documents of components.
- Installation and wiring must be carried out by a licensed electrician qualified as per local and national electrical codes.
- Wear protective gloves when operating the equipment. The sharp edges might cause personal injury.
- Possibilities of strong winds or earthquakes should be considered before installation.

Caution

- To reduce the risk of fire, the branch overcurrent protection should be connected according to national electrical codes.
- Please handle the product with caution during transportation.
- Use appropriate handling equipment for shipment, and make sure that such equipment is capable of bearing the weight of the product.
- Failure to comply with the minimum requirements regarding the size and length of cables can result in system interruptions or unreliable operation. It is crucial to adhere to these minimum values, as not meeting them may lead to problematic performance.

Min. installation distance

Room for clearance should be reserved on the left, right, top, bottom and front sides for proper installation of the MANGO POWER M - as illustrated above. Do not place any objects on top of the M Hybrid Inverter or the M Cabinet as it presents a major risk for fire or severe injury as a result of high temperatures. If the MANGO POWER M is to be installed in an outdoor area with eaves, a clearance greater than 36 inches (914 mm) must be reserved for the eaves.

In the case of parallel connection for multiple M Hybrid Inverters, the minimum clearance of installation is 15.7 inches (400 mm), as shown below.

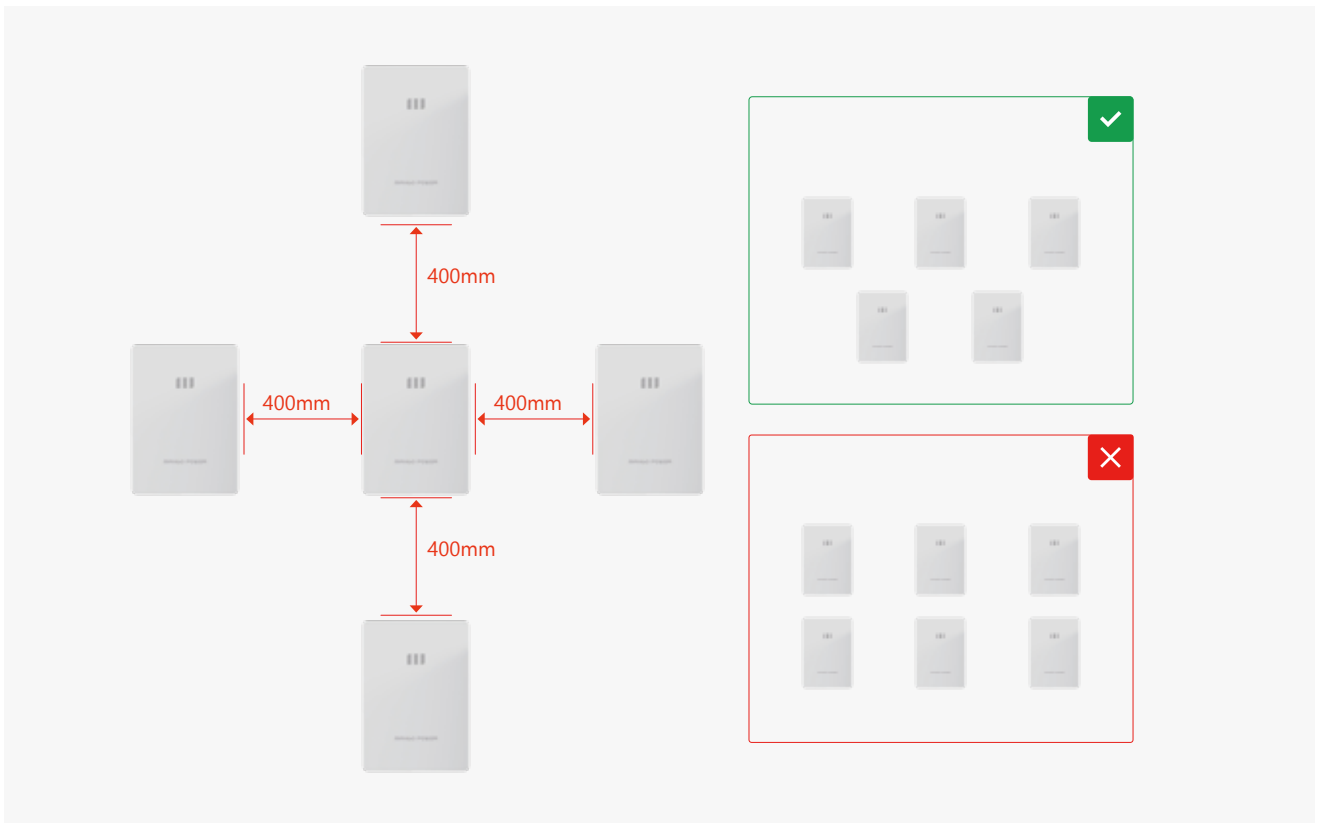
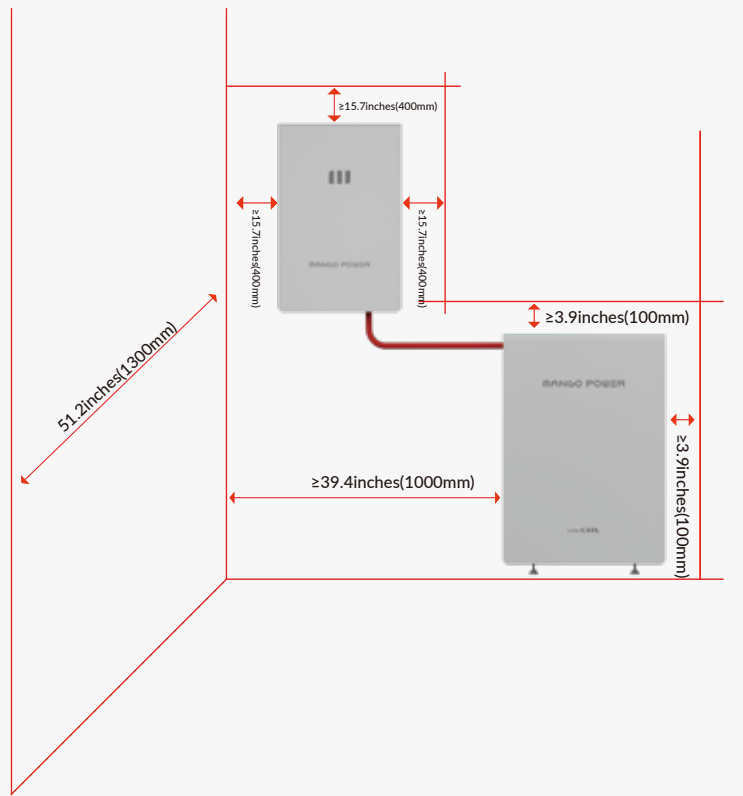

7 Wall Mounting

The product must be mounted onto a wall with consideration given to the appropriate environment described in “Instructions on Installation”. Installation should be carried out accurately and safely as described below.

7.1 M Hybrid Inverter 12kW Wall Mounting

The M Hybrid Inverter must be wall-mounted, and should be installed onto a vertical and sturdy brick, concrete, or wooden frame wall. Since the inverter is very heavy - about 121 lbs. (55 kg) - two or more people will be required for installation. The slots on the mounting bracket can accommodate a stud spacing of 12~16 inches (305 ~406mm).

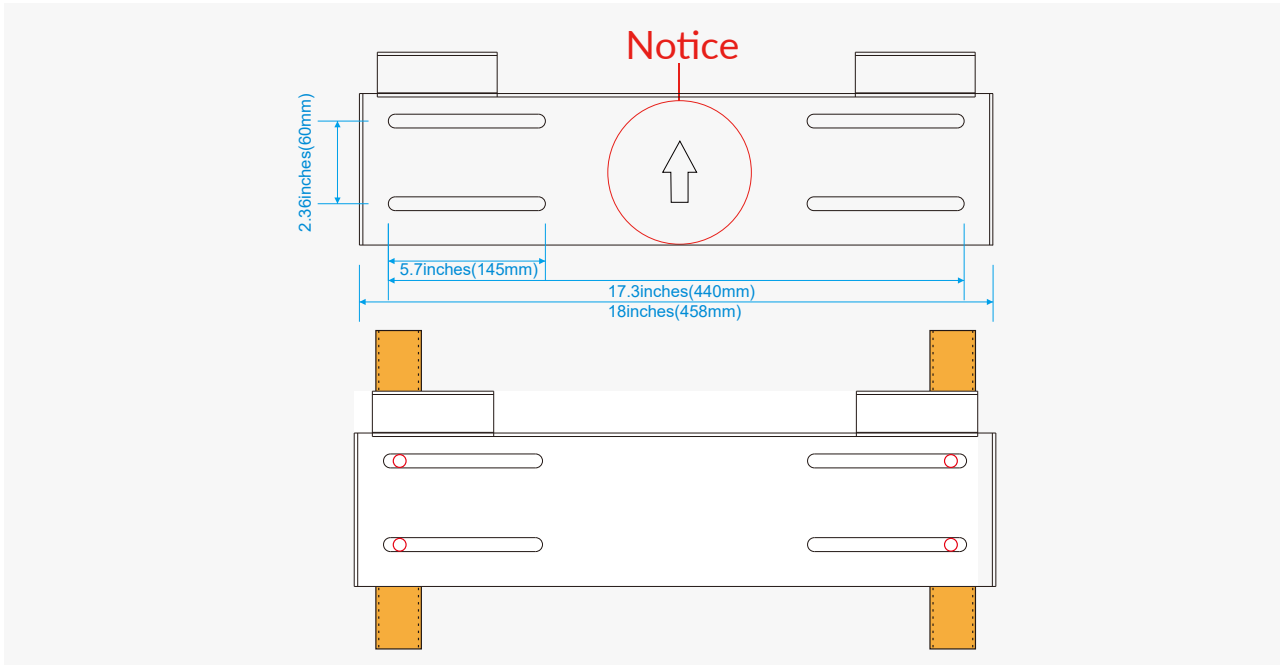

Installation steps:

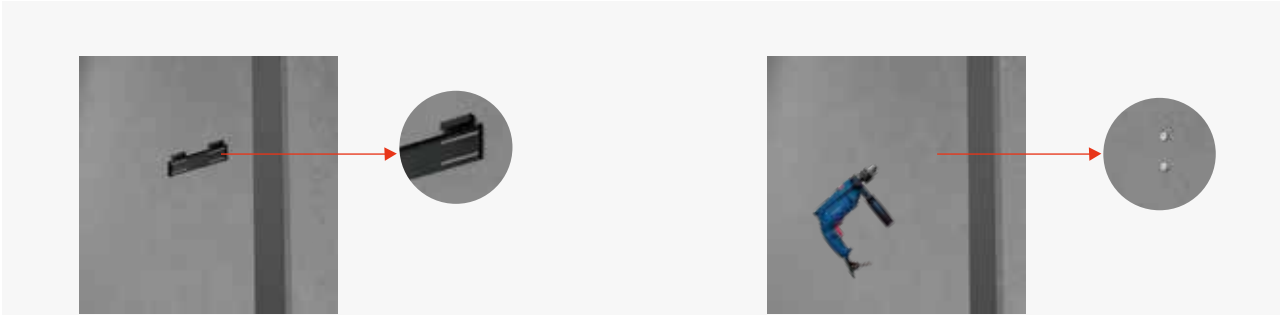

Step 1. Place the wall bracket on a wall that meets the required installation and clearance conditions. Mark the positions of the drill holes with a pencil then drill four holes of 5/16 inches (8mm) in diameter. Make sure the holes have a depth in excess of 2 inches (50 mm).

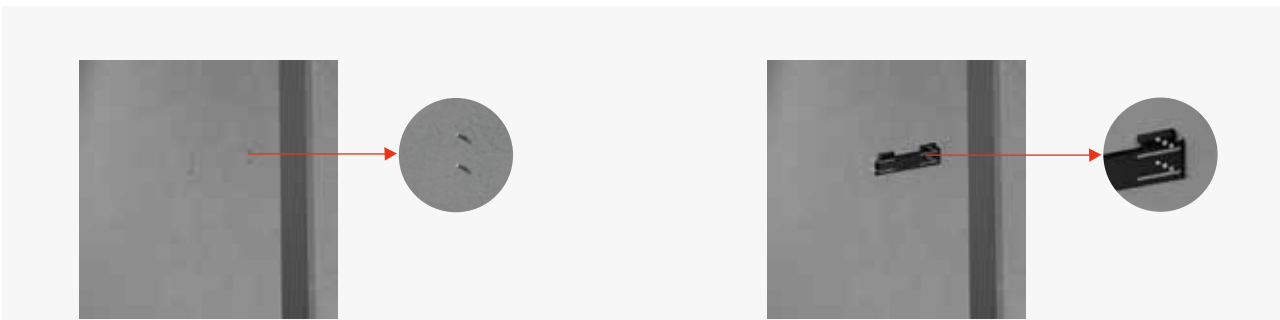

Step 2. If the wall of mounting is concrete or brick, insert M8x80 expansion bolts into the holes and fasten them then fix the wall-mounted bracket onto the wall.

Note:

If the wall is made of wood, please fix it with M8x45 hexagon dovetail self-tapping screws.



Step 3. Hang the inverter on the wall-mounted bracket. Fix in the wall-mounting fasteners and the inverter with M5x10 combination screws. Mark the positions of drill holes with a pencil then drill 2 holes of 5/16 inches (8mm) in diameter. Make sure the holes have a depth in excess of 2 inches (50mm). Lock the inverter onto the wall through the wall-mounting fasteners with 2 M8x80 expansion bolts in the box.

Note:

If the wall is made of wood, please fix the wall-mounting fasteners with M8x45 hexagon dovetail self-tapping screws.

7.2 M Cabinet Wall Mounting

The M Cabinet hanger can be used as position fasteners only. It cannot serve as a load-bearing component for wall mounting (i.e. the battery rack should not hang in the air upon installation).

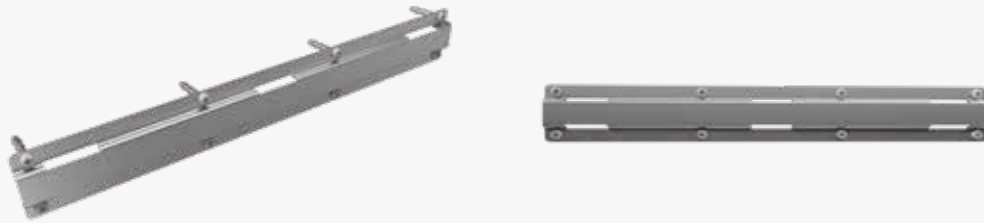

Step 1. Determine the position of hanger 1 based on the mounting position of the M Cabinet. Mark the positions of drill holes with a pencil. Drill holes with an electric drill. Install expansion plugs then install the hanger in place with M5x32 self-tapping screws.

Note:

If the concrete ledge protrudes, please make the installation using hanger



Step 2. Take out M5x12 hexagon combination screws from the box and install battery rack hooks onto the housing one by one.



Step 3. Mount M Cabinet onto the hanger.



Step 4. Mount hook covers onto the M Cabinet one by one as illustrated.

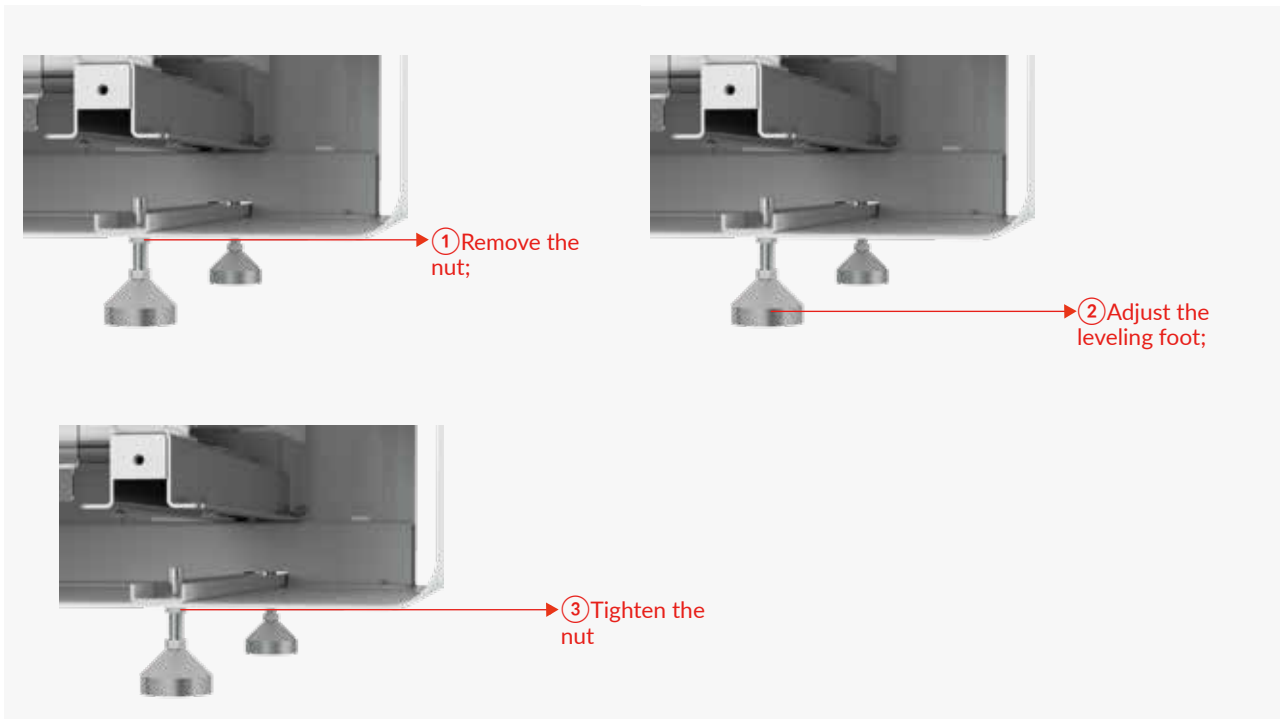

Step 5. Upon wall mounting, if the M Cabinet wobbles, please adjust the corresponding leveler based on the position of wobbling:

a. Loosen the screw (clockwise) under the M Cabinet foot with an adjustable wrench. The distance of the foot is 1.2 - 2.2 inches (30 ~ 55mm) above ground. The regulation range of the foot is 1 inch (25mm).

b. Adjust the foot manually as needed so that the 4 feet of the M Cabinet stand stably on the base. Tighten the screws loosened earlier (counterclockwise) with the wrench. Double-check if the M Cabinet is stable. If yes, the wall mounting of the M Cabinet is complete.

7.3 Installation of the M Battery 5kWh and M Cabinet

TAn M Cabinet can accommodate up to 4 M Batteries. You can choose 3 - 4 M Batteries as needed. Please follow the steps below for installation. Please ensure that the M Batteries are installed in a reliable and steady way.





Step 2. Mount Batteries into M Cabinet.

- a. Make sure the “ON/OFF switch” of M Batteries is toggled OFF.
- b. The M Battery should be installed preferably near the signal port, as shown in Fig. ①. In case of more than one battery, follow Fig. ②/③/④ based on the quantity.



M6X16 hexagonal bolts (with flat washer)

- c. Take out the M6x16 hexagon combination screws from the M Battery box and mount the M Battery onto the housing. Please be cautious when mounting the M Batteries. When the batteries are in position, they should be fixed into place with screws first.

Note:

If more than one M Cabinet is installed for expansion, a clearance on the left of ≥ 39.4 inches (1,000mm) and right of ≥ 3.9 inches (100mm) should be reserved. If that installation distance is inadequate, you should move the M Cabinets to the wall with a special trolley upon installing the M Batteries on the cabinet. Please follow 7.2 - 7.3 to properly mount the M Cabinets onto the wall.

8 Wiring

Prior to wiring, always place a warning sign on top of the M Cabinet to warn others of the risk of electric shock, injury, or damage if misused.



During the wiring process, please prioritize the connection between the M Hybrid Inverter and M Cabinet over the installation wiring of the M Cabinet and M Battery. When removing the system, please remove the connection between the M Cabinet and M Battery prior to removing the one between the M Hybrid Inverter and M Cabinet.

There is no primary switch for control after installation of multiple M Batteries. M Batteries are switched on after installation of M Cabinet and carry a strong current. Please take caution when performing the installation.

8.1 Overview of System Wiring

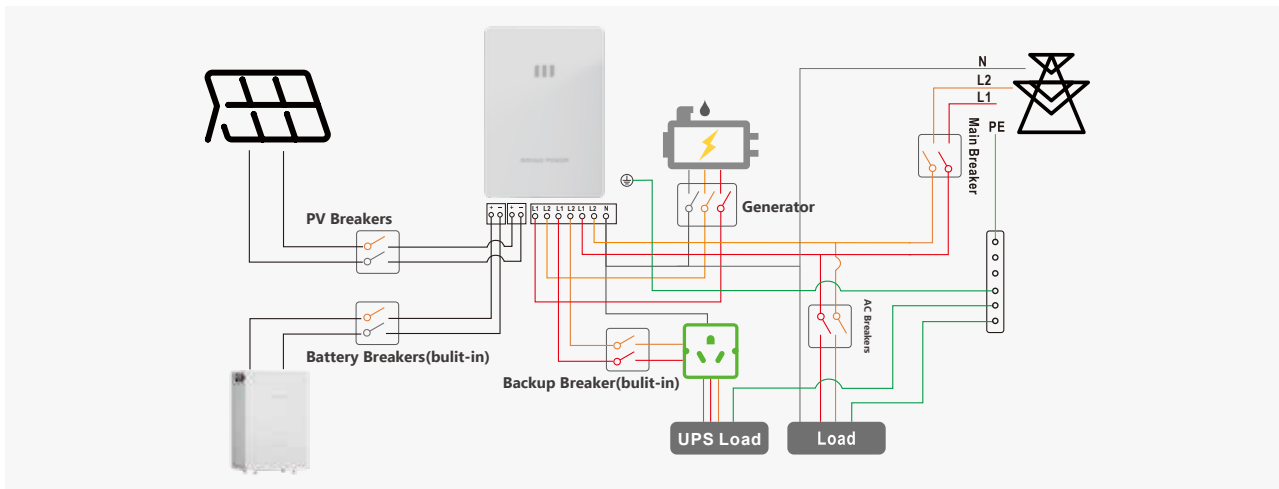

! Note:

Prior to system wiring, please connect the M Smart Screen with the M Hybrid Inverter to set the system and confirm if wiring is correct during installation.

- Take out the HDMI cable from the M Hybrid Inverter box. Fix the cable (the end with the Type C fastener) into the inverter interface with M3x10 hexagon combination screws.
- Plug the other end of the cable into the interface at the back of the M Smart Screen.

8.2 M Hybrid Inverter 12 kW Wiring

Preparations:

- Open the front enclosure of the M Hybrid Inverter with a key to reveal the junction box.



! Note:

You can remove the front enclosure for the convenience of wiring. If you do so, please keep the screws properly for reinstallation after wiring.

- Toggle off the BATTERY+ Breaker, LOAD Breaker and PV switch in M Hybrid Inverter.

- Remove the round cover under the M Hybrid Inverter. Thread cables as they're labeled up the holes and connect them. With the correct wiring confirmed, seal the holes with fireproofing clay.



Note:

- When the wiring preparation is done, please connect PE, N, L1 and L2 of the M Hybrid Inverter with those of the household backup power cabinet. Please also check if the PE and N are short-circuited in your household backup power cabinet. If yes, no additional short-circuit is required for the M Hybrid Inverter. If not, you should short-circuit the PE and N of the M Hybrid Inverter.
- The anode+ and cathode- of M Cabinet carry large currents. CT and communication cables should not share the same ingoing hole with M Cabinet anode+ and cathode-.
- For the removed round cover, if it's not threaded, please seal it with the nylon locking nuts in the box.

8.2.1 PV Connection

PV connection of the M Hybrid Inverter is the same as that for a conventional grid-connected solar inverter (series inverter).

Cable specification	Max. voltage
10~8AWG (5~8mm ²)	600V

Warning:

Please double check the min. ambient temperature of the installation position. The temperature corresponding to the rated voltage of the PV panels is 25°C. Any temperature drop from this will lead to an increase in the voltage of the PV panels. Please ensure that the max. voltage calibrated of the PV panels at the lowest temperature does not exceed the max. input voltage (550V) of the inverter.

Note:

- The inverter comes with 3 MPPT functions. On MPPT1, two strings can be connected. On MPPT2 and MPPT3, one string can be connected.
- Connecting 2 strings to MPPT1 requires an equal number of PV panels on these two strings. The inverter will automatically limit the total MPPT1/MPPT2/MPPT3 input current to 25A/15A/15A respectively.
- The inverter will limit the max. PV power input to a total of 18 kW.

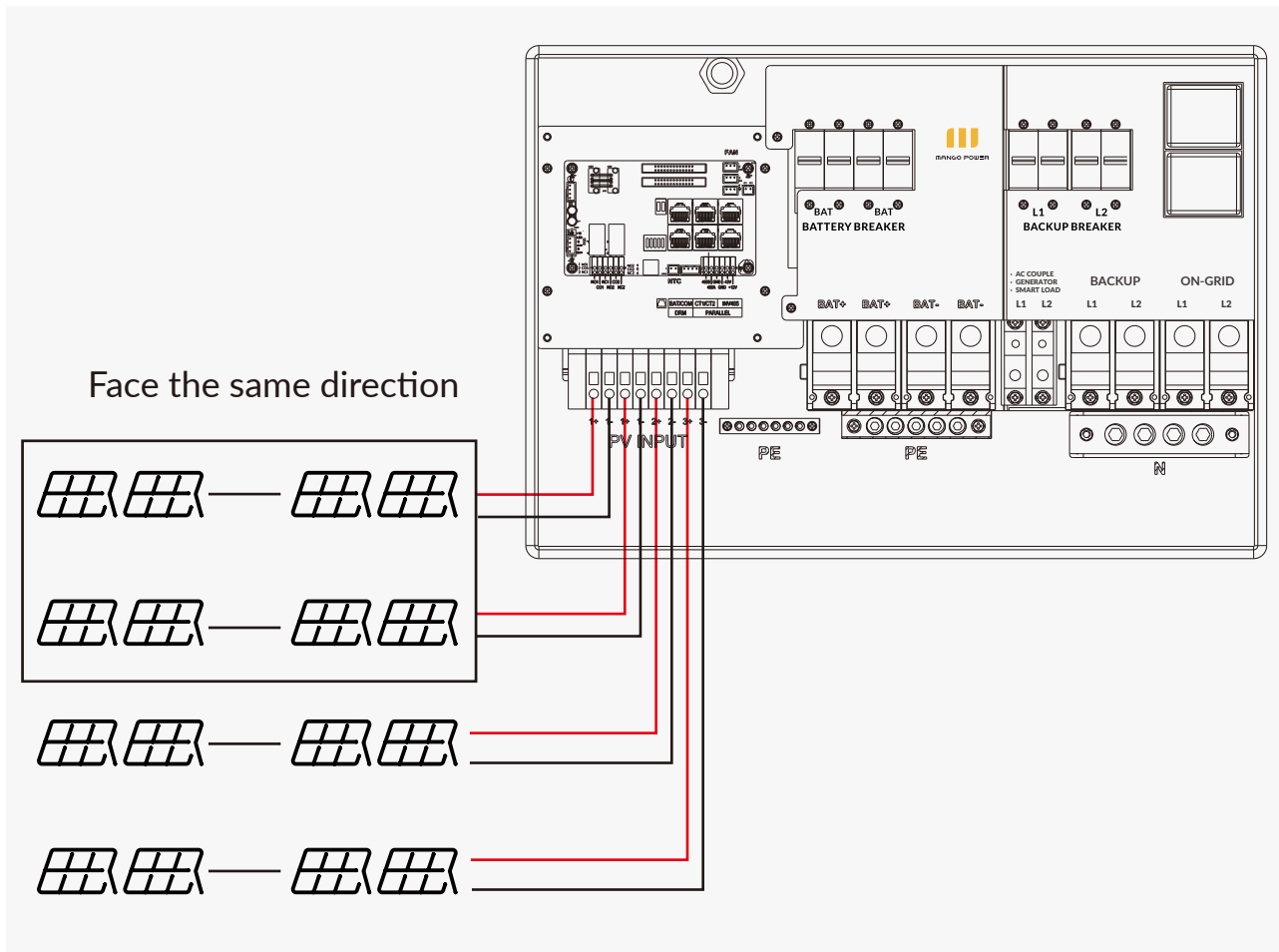

Steps of PV wiring:

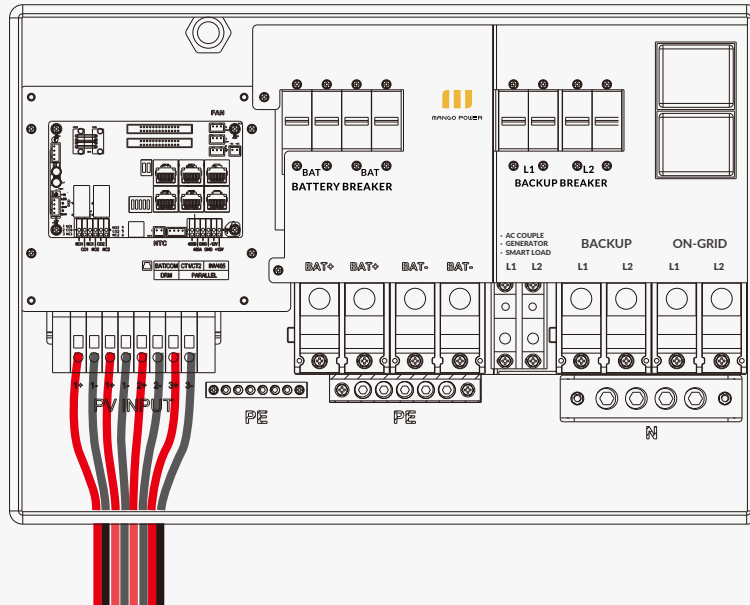

- Step 1.** Strip the anode+ and cathode- wires of PV panels by 1/4 - 5/16 in (6 ~ 8 mm).
- Step 2.** If the PV cable is stranded, please use the cable harness terminal.
- Step 3.** Plug conduit connector into the PV interface and tighten it from the inside with a reverse nut.
- Step 4.** Connect the PV cable to the inverter through the conduit connector.
- Step 5.** Check if the cable is correctly and solidly connected. Ensure that the conduit is properly secured by fasteners. Seal cable inlets with fireproofing clay.

8.2.2 M Cabinet Connection

Take out the anode+, and cathode- cables from the packaging box of M Cabinet and thread them into the sleeve of ID 1.5 inches (38.1mm) prepared in advance.

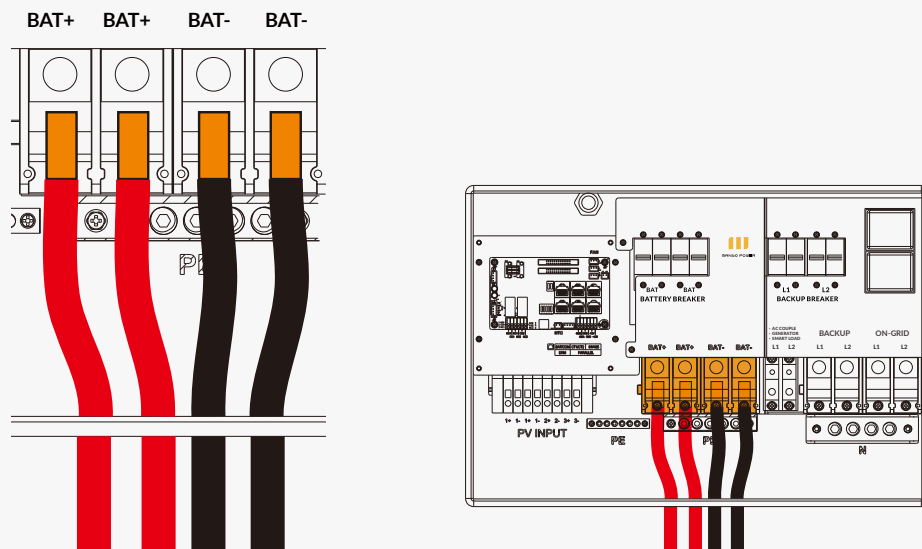

- Step 1.** Connection of the battery anode+ and cathode- cables. Connect the anode+ cable to BAT+ and M Cabinet "+", and cathode- cable to BAT- and M Cabinet "-".

⚠ Warning:

To prevent damage to the inverter, avoid connecting the anode and cathode cables in reverse polarity.

Note:

- When you hear a click, the anode+ and cathode- cables of the M Cabinet are installed in place.
- Cables can be cut on site as you see fit for installation. If the cables supplied are not long enough, please buy more based on the specifications. For cable specifications, please refer to 4.2 herein.

Pin	Description
1	NC
2	GND
3	NC
4	BAT CAN H
5	BAT CAN L
6	NC
7	BAT RS485 A
8	BAT RS485 B

Step 2. Connection of battery communication cables. Open the packaging box of the M Cabinet and take out the RJ45 connector. Install the connector to the M Cabinet signal port. Take out the signal cables from the box of the M Hybrid Inverter. Connect the signal port of the M Cabinet and the battery port of the M Hybrid Inverter.

Note:

- The battery communication port of the M Hybrid Inverter is RJ45. For definitions of RJ45 pins, please refer to the content above. CAN and RS485 communication is supported.

With the power supply and communication cables connected for the M Cabinet, please access the screen of advanced settings on the M Smart Screen and specify the battery type and brand.

8.2.3 Grid & BACKUP Connection

The M Hybrid Inverter can be used with a 120/240V split-phase or 120/208V split-phase.

The inverter has passed the main grid-connection regulations in the US (IEEE1547, CA Rule 21, HECO Rule 14H, etc.). If the grid is connected to the Inverter, make sure that the grid settings are set correctly. Users can choose different Grid Types and regulations in Advanced program on the M Smart Screen as below:

8.2.3.1 Grid and BACKUP Connection for Split-Phase Service

The connection diagram for 120/240V is as below. The connection diagram for 120/208V split-phase service is roughly the same except that the generator is not supported. The inverter can be connected to the load side of the service disconnecting means if the busbar rating in the main panel can meet the NEC705.12(B)(3) requirements. Otherwise, a Line side connection can be made to avoid an expensive main panel upgrade.

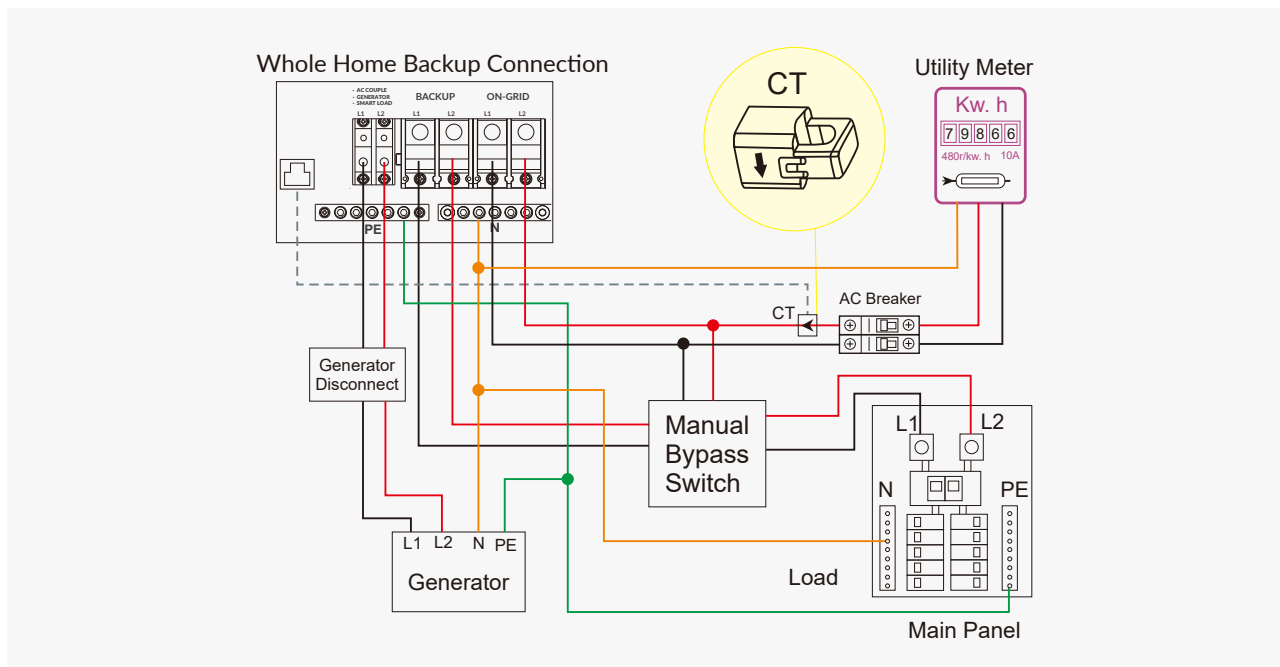
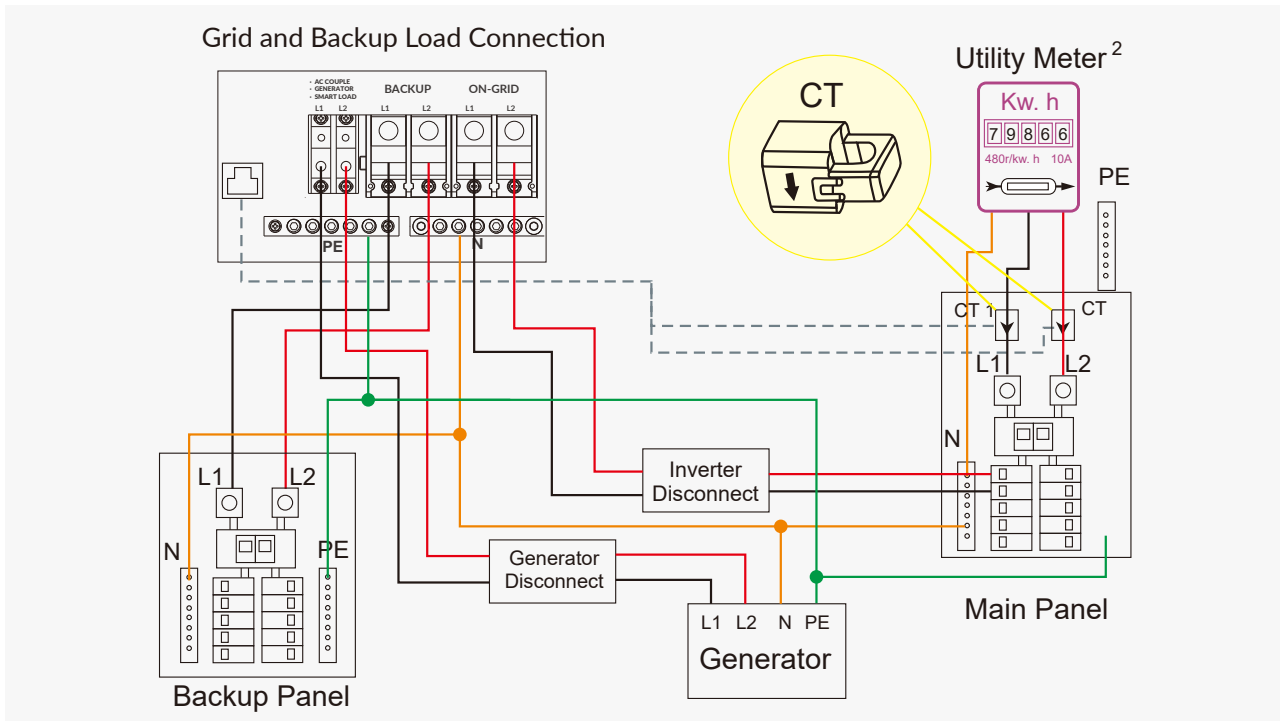

8.2.3.2 AC Cable Connection

The M Hybrid Inverter can be used with a 120/240V split-phase or 120/208V split-phase.

Requirements on cables:

Current	Sectional area	Diameter	Min. voltage	Tightening torque for cable connection
100A	3~2AWG(25~35mm ²)	6~7mm	600V	7(N.M)
200A	1/0~2/0AWG(55~70mm ²)	8~9mm	600V	33(N.M)

- Strip off 5/16-3/8inches (8~10mm) of insulation sleeve on the cables.
- Use wire ferrules if the cables are colored fine stranded wires.
- Secure the conduit fitting to the enclosure using the counter nut of the fitting.
- Fasten the grid and EPS load cables to the terminal block in accordance with the markings.
- Secure the conduit to the conduit fitting.
- Check that the cables are connected correctly and securely. Ensure that the conduit and conduit fitting are secured reliably then seal the cable entry holes.

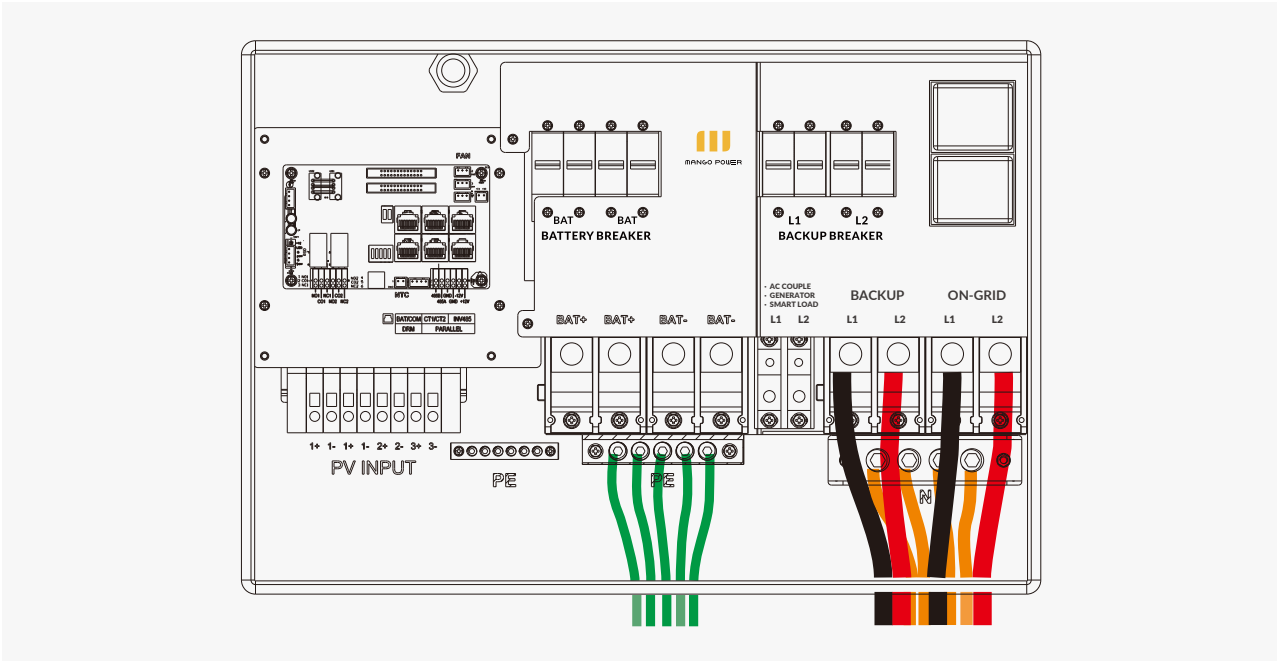

Warning:

Before powering on BACKUP, toggle Breaker to On position.

8.2.3.3 CT connection

To measure the power imported from and exported to the grid, a pair of CTs or one triphase meter must be installed at the service entry point in or near the main service panel.

Pin	Description
1-4	Reserve
5	CT1N
6	CT2P
7	CT1N
8	CT1P

Note:

- The CT interface for 2 CTs connection is a RJ45 port, the RJ45 plug on those 2 CTs have been made in advance so you may connect it to the port directly.
- Please refer to the connection diagram for the correct positions of CTs and clamp the 2 CTs on the L1 and L2 wires at the service entry point in the main service panel. CT1(label L1) should go to L1 and CT2 (label L2) should go to L2. The arrow on the CT is pointing to the inverter. (***) An incorrectly installed CT will cause the Display to show incorrect information and features will not function correctly) If the CTs are in a wrong direction, there is an option to change the direction of the CT on your inverter call: CT Direction Reversed (Only for Direction not CT1 or CT2 Placement) in Advanced Tab. Changing it physically is unnecessary.

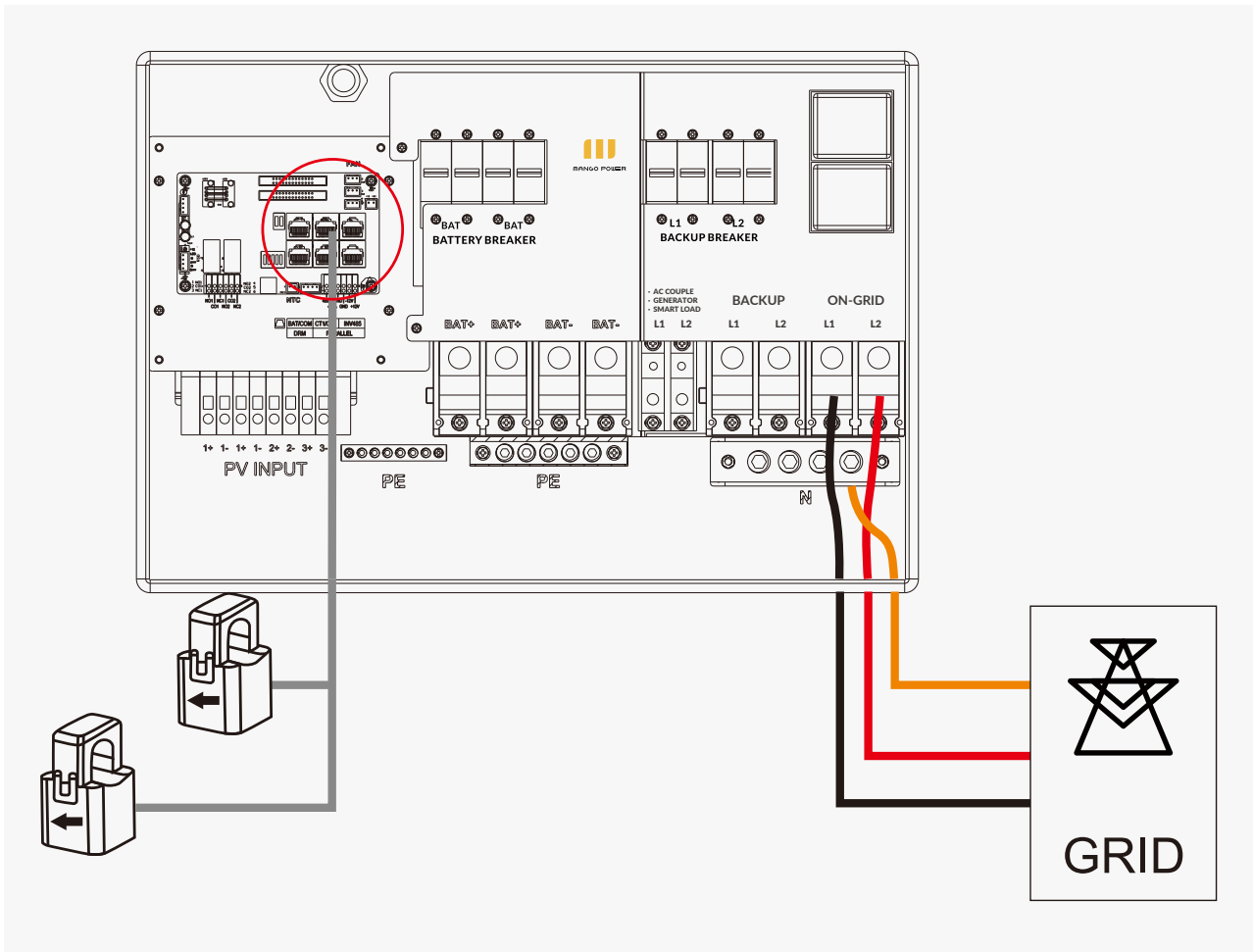
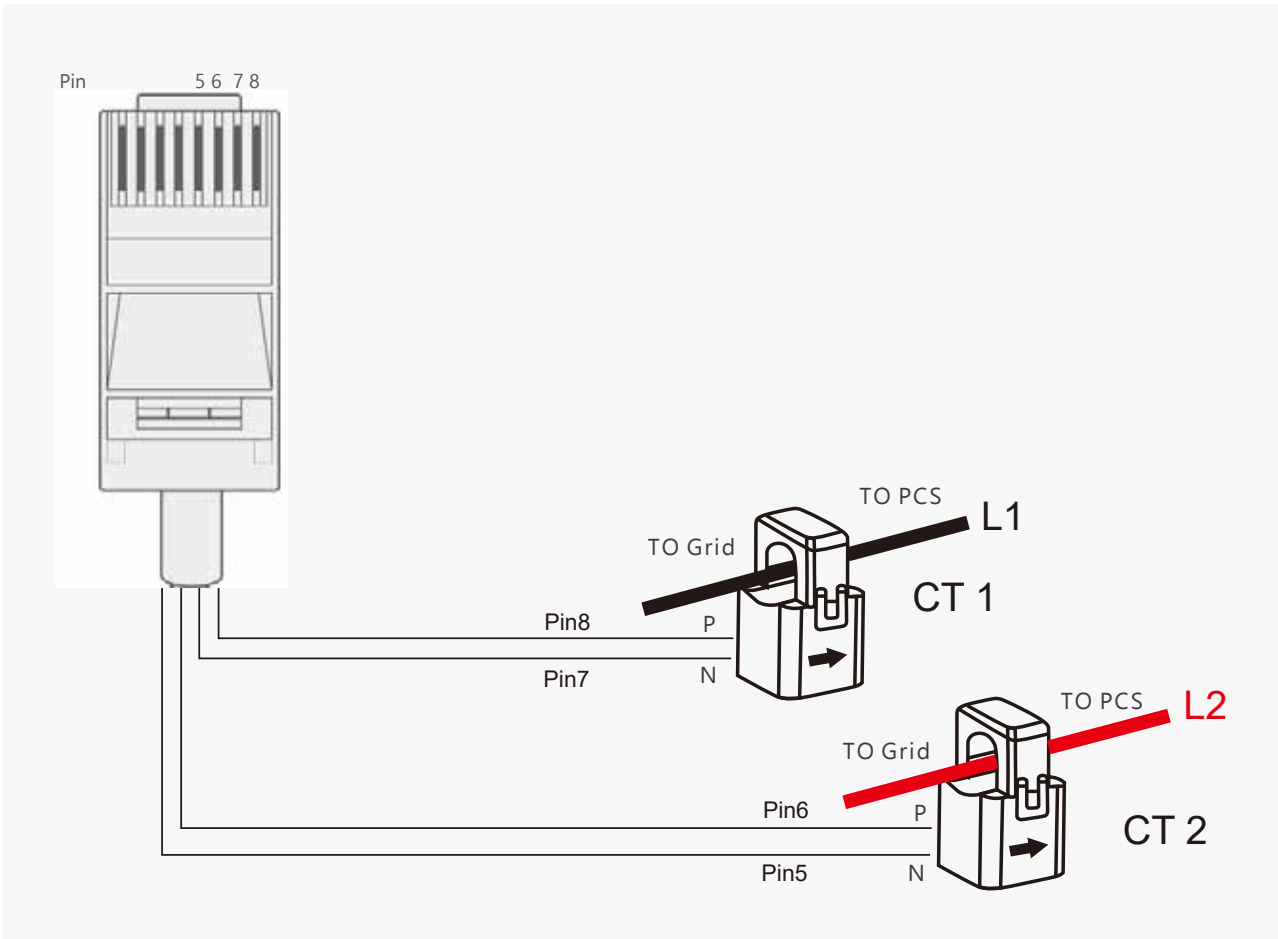

Note:

- CT ratio. The CT ratio distributed is 3,000: 1. If you are using a third-party CT, please ensure that the CT ratio is 1,000: 1, 2,000: 1, or 3,000: 1 then select the correct CT ratio setting on the inverter monitoring page of the M Smart Screen.
- Extension of CT cables. CT cables can be extended with regular Ethernet cables. An RJ45 connector is required for the extension. You may extend the CT cable up to 100m (300 ft).



8.2.3.4 Meter Connection

If you need to use a meter for import/export detection instead of CTs, you need to connect it to the Meter 485A and 485B terminals on the inverter.

8.2.4 Generator System Connection

The M Hybrid Inverter can work with a generator. There are Generator ports on the inverter for a generator connection.

Generator requirements: The generator should be neutral bonded type, with 240V/120V output at same time, generator capacity should be larger than 6kW.

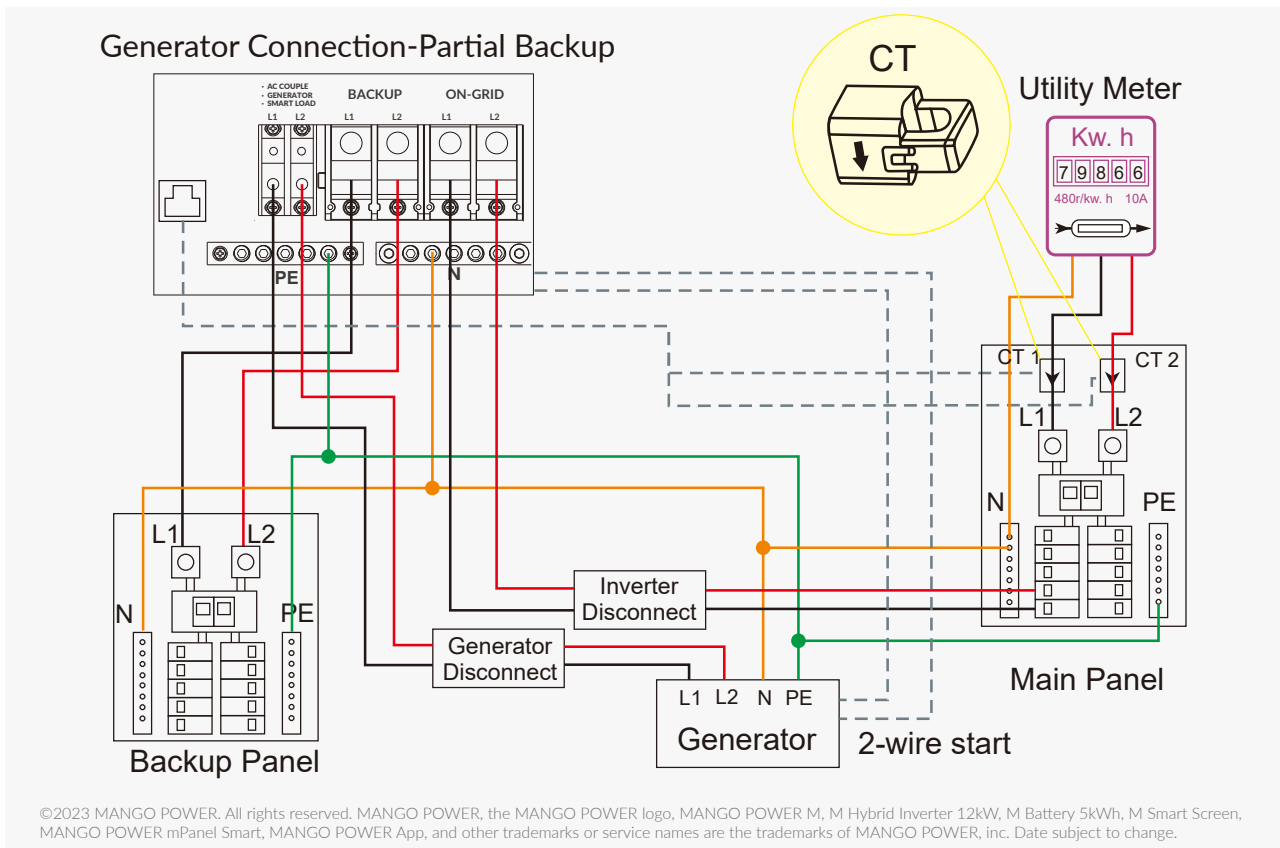

Generator Connection-Whole Home Backup

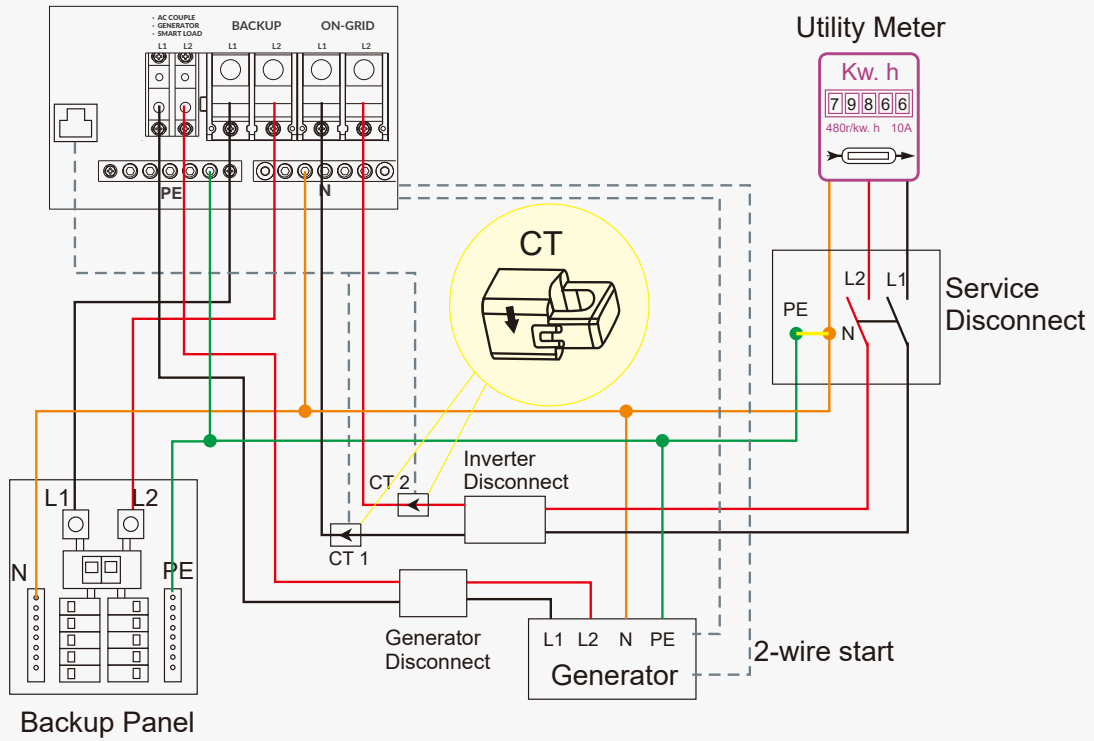

When starting the generator, power for all loads connected to BACKUP will be supplied by the generator. The batteries will be charged as well while this happens.

The direct relay at the generator port is 90A. When the generator is in operation, please ensure a total current no greater than 90A from loads and charging.

If you wish to control the generator remotely through the inverter, the start-up signal of the generator should be connected to the GEN Nominal Open (NO1 and CO1) or Nominal Closed (NC1 and NO1) ports on the COM circuit board.

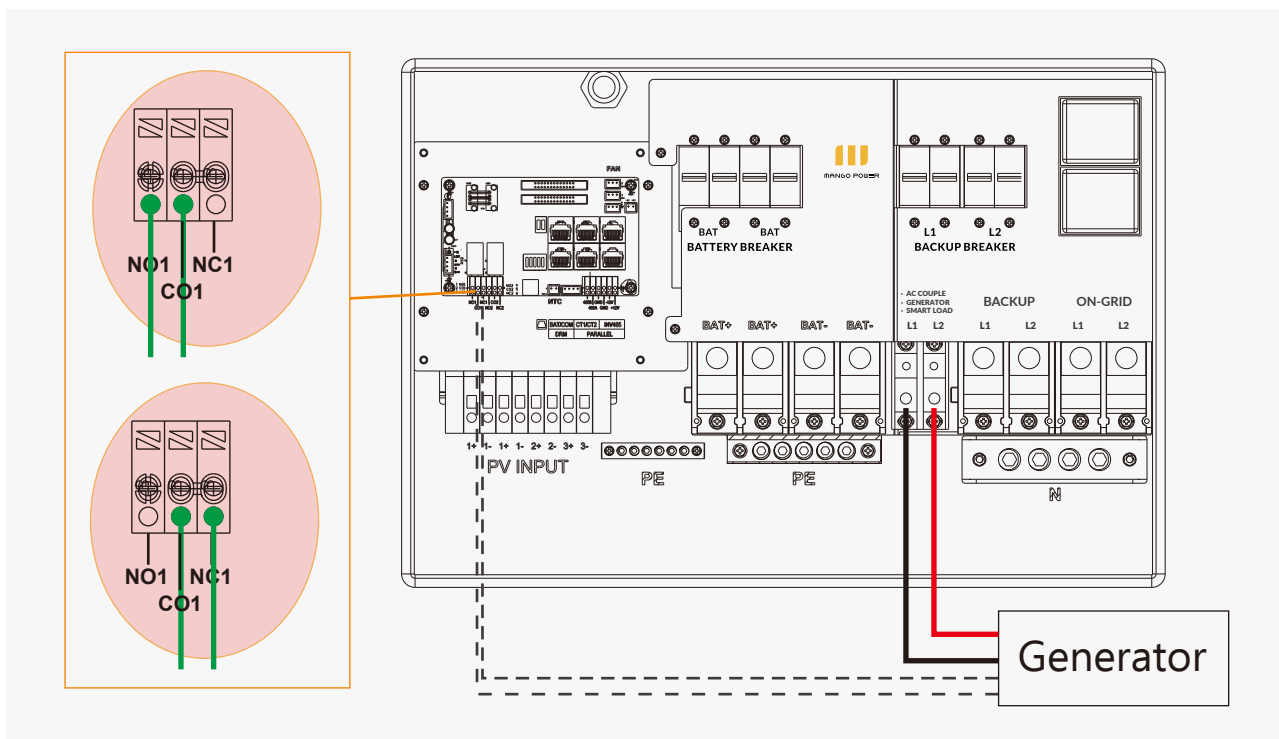

Based on charge control settings of the batteries, the system can determine if the generator is required according to the battery SoC.

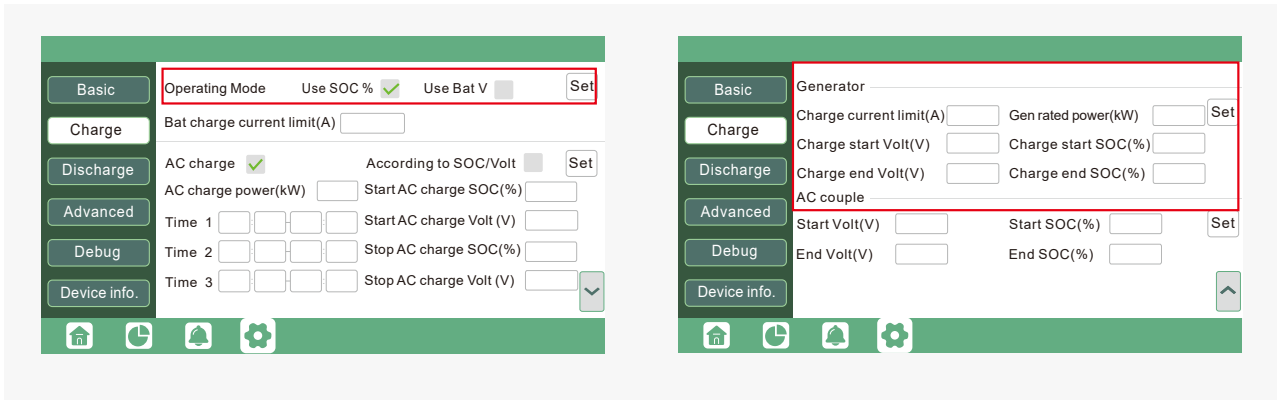

Conditions for generator start-up

If grid power is faulted and batteries have been discharged to the set cut-off point, there is a forced charge request from batteries, or if the battery SoC falls below the SoC setting for generator start-up.

Conditions for generator shutdown

If the battery SoC is higher than the SoC setting for discharge end.

8.2.5 AC Coupling Connection

The inverter supports AC coupling connection with the existing grid-interactive solar system. The existing solar system is connected to the inverter's Generator port.

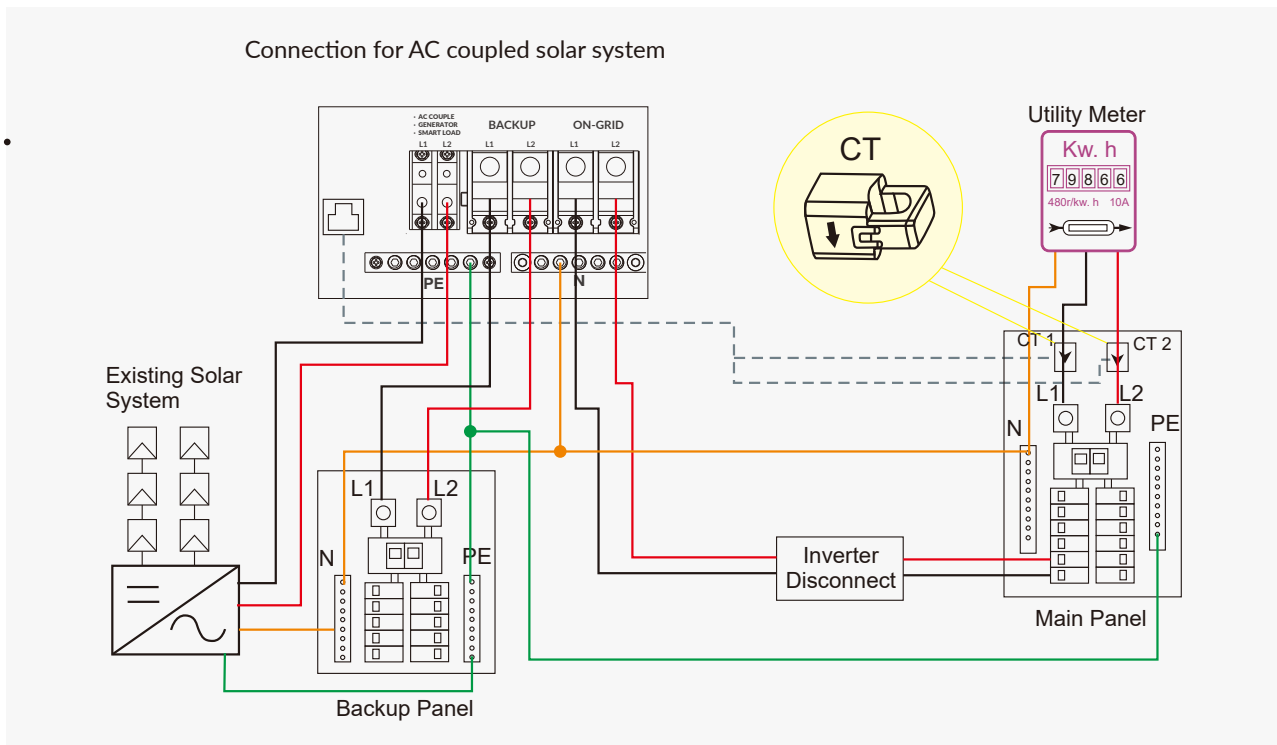

After the AC couple function is enabled:

When the grid is on, the generator terminal is connected to the grid terminal inside the inverter. In this case, the M Hybrid Inverter will bypass the interactive inverter AC to the grid and backup. When the grid is off, the Generator terminal is connected to the backup terminal inside the inverter. In this case, the hybrid inverter will work as a power source for the grid interactive inverter to synchronize and feed power to the micro-grid. The loads will be first supplied by solar power. If solar panels are generating more power than load consumption, the excess solar power will be stored in the battery. When solar power exceeds the sum of load power and max. battery charging power - when the battery is nearly full, the inverter will signal the grid interactive inverter to reduce power via the frequency shifting power reduction mechanism to maintain the balance of generation and consumption of the micro-grid system.

AC Couple Settings

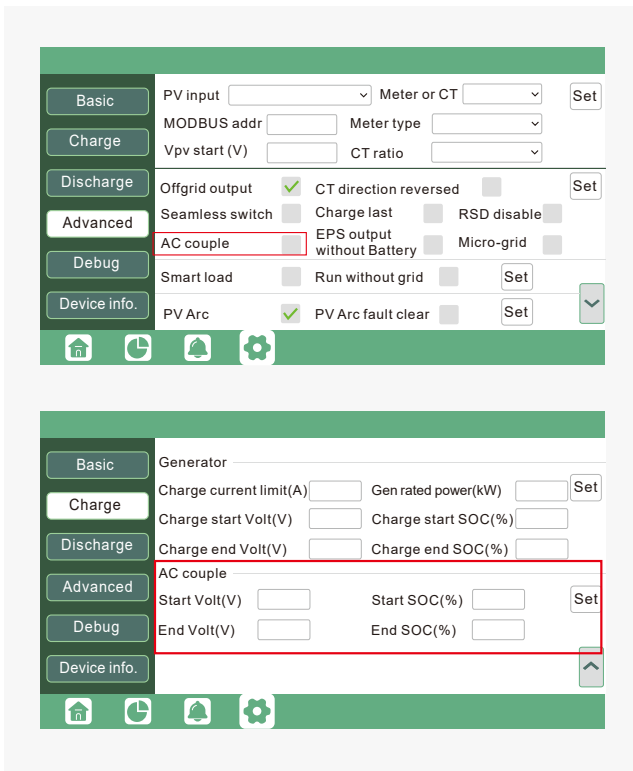

Users need to enable the AC coupling function when they connect an existing on-grid system to the generator terminal.

Start SOC (%): The SOC at which the AC coupled inverters are turned on when in off-grid mode. 50%~70% recommended.

End SOC (%): The SOC at which the AC coupled inverters are shut down when in off-grid mode. 90% recommended.

When On-Grid and Export to Grid are enabled, the AC-coupled inverter will always be on and will sell any extra power back to the grid. Ensure you are allowed to sell power to your utility provider when using AC Coupled PV Arrays on-grid.

8.3 Connection Between the M Battery 5kWh and M Cabinet

Please make sure the “ON/OFF switch” of M Batteries is toggled OFF prior to the connection.

Step 1. Take out the ground wire from the packaging box of the M Battery 5kWh and connect the ground point on the M Battery enclosure with the ground copper busbar of the M Cabinet using M6x16 cross-recess hexagon combination screws. If you have more than one M Battery, the ground wire of each M Battery should be connected to the ground copper busbar.

Step 2. Take out the anode+ and cathode- cables from the packaging box of the M Battery. Connect anode+ cable to P+ and the anode+ inside the M Cabinet, and cathode- cable to P- and M Cabinet cathode-.



! Note:

- The slots on anode+ and cathode- cable terminals should be aligned with those on the M Battery and M Cabinet terminals.
- When you hear a click from the M Cabinet anode+ and cathode- interfaces, the cables are installed in place.

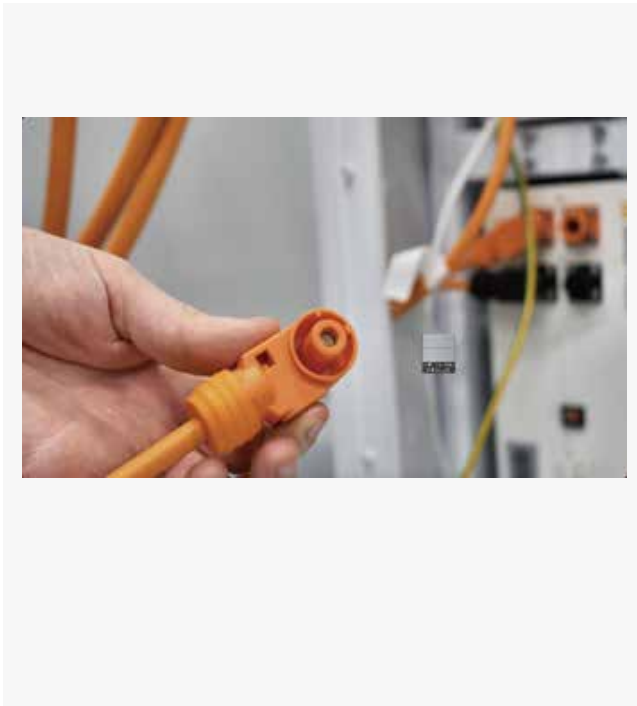

Internal signal line

Battery communication line

Step 3. Connect the CAN communication interface on the M Battery using the signal cable integrated in the signal port of the M Cabinet. Set the DIP switch of the M Battery on the inverter as 1, and flip the switches of the rest of the M Batteries in sequence while making sure each M Battery has a different code. Connect the uppermost group. For M Batteries starting from the second group counted from the top to the bottom, connect the RS485 parallel communication ports of adjacent batteries in sequence with the communication cable from the packaging box of the M Battery.

Note:

In case of multiple parallel M Batteries, you can distinguish them by setting the address via the DIP switch on BMS. Sharing the same address should be avoided. For definitions of BMS DIP switch, please refer to the following.



Address	Position of Dip Switch			
	#1	#2	#3	#4
1	ON	OFF	OFF	OFF
2	OFF	ON	OFF	OFF
3	ON	ON	OFF	OFF
4	OFF	OFF	ON	OFF
5	ON	OFF	ON	OFF
6	OFF	ON	ON	OFF
7	ON	ON	ON	OFF
8	OFF	OFF	OFF	OFF
9	ON	OFF	OFF	ON
10	OFF	ON	OFF	ON
11	ON	ON	OFF	ON
12	OFF	OFF	ON	ON
13	ON	OFF	ON	ON
14	OFF	ON	ON	ON
15	ON	ON	ON	ON
16	OFF	OFF	OFF	OFF

Battery parallel cable

Step 4. Take out the parallel cable from the box of the M Battery and connect the parallel communication ports of adjacent batteries with it.

Step 5. Install the side cover. Double-check the wiring inside the M Cabinet and the tightness of the screws then install the cover back onto the housing with the removed M4x8 countersunk screws. Put the plug clips back in and your installation is complete.

Note:

- The M Battery has no switch control outside the M Cabinet. Therefore, please ensure that the “ON/OFF switch” of the M Battery is ON before installing back the side cover.
- When wiring the MANGO POWER M following the above mentioned steps, please check if the system works properly as per 8.5 herein before installing back the side cover and plug clips of the M Cabinet. Avoid removing the side cover repeatedly.

8.4 Connection Between M Hybrid Inverters and M Cabinets

The MANGO POWER M can support up to 10 sets of M Hybrid Inverters and M Cabinets in parallel - expanding the battery capacity to 800 kWh. The M Hybrid Inverter supports parallel connection to expand power consumption and energy capacity, paralleling up to 10 units and reaching a power of 120 kW to accommodate different applications.

8.4.1 M Hybrid Inverter Parallel System Connection

a. 12kW x 6 Parallel system installation connection (6 @ 240V/120V)

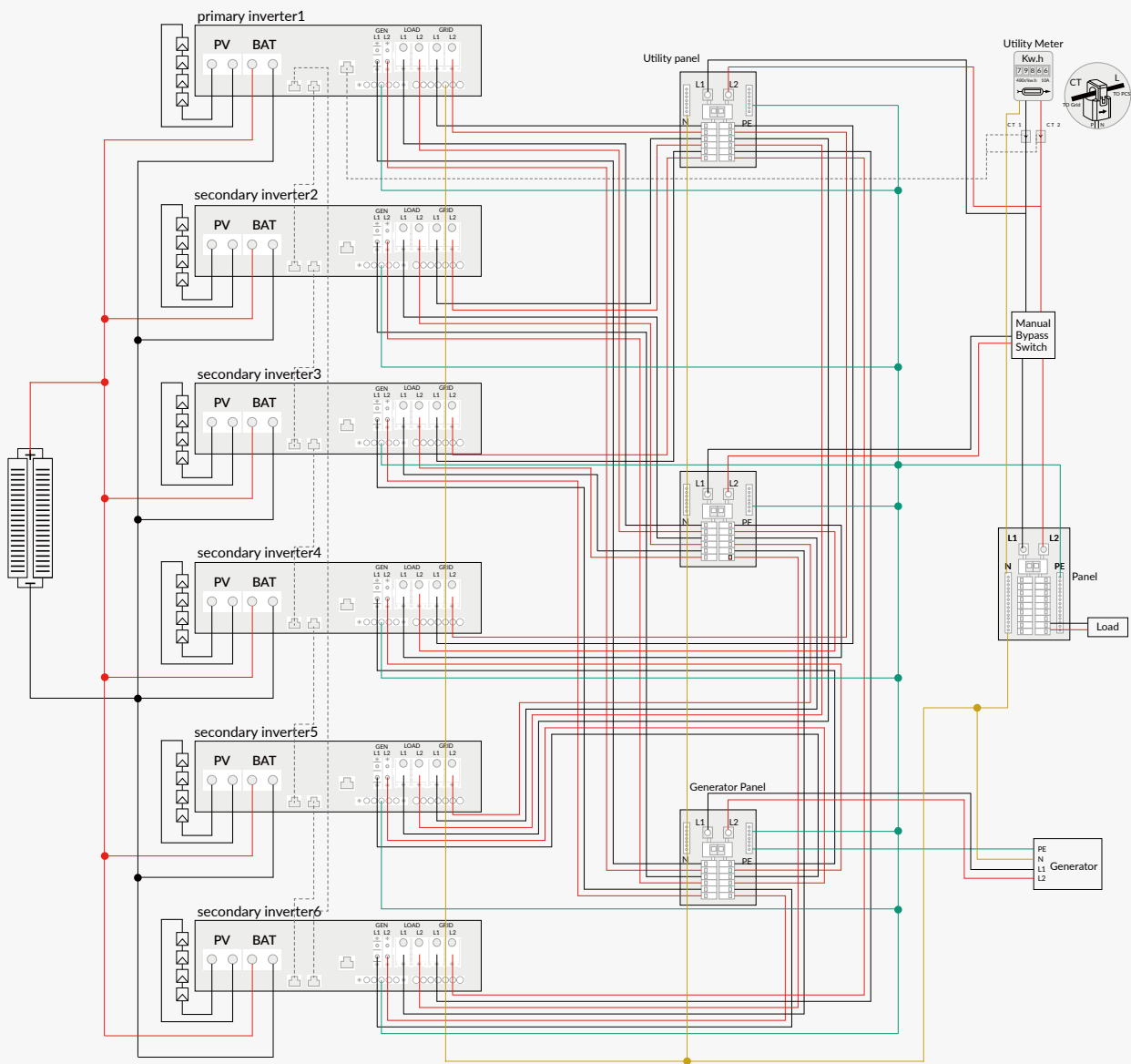

Step 1. The wiring diagram is shown below. It is set by default to bypass the switch manually and connect loads to the backup port. When the inverter is faulted, the user can toggle the loads to utility power.

Please toggle ON the 2-bit CAN balancing resistor of the first and the last inverters in the orange chain.

Grid type setting for each inverter

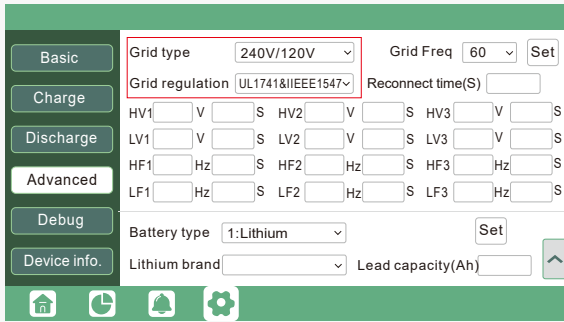

Inv1 setting

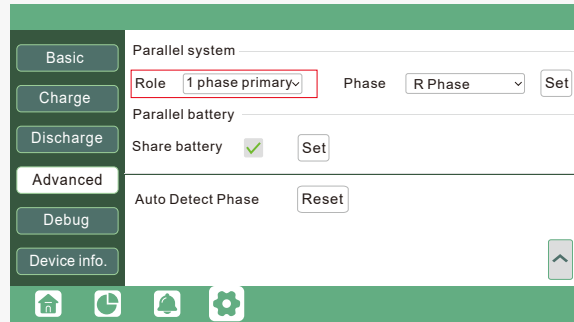

Inv2 setting

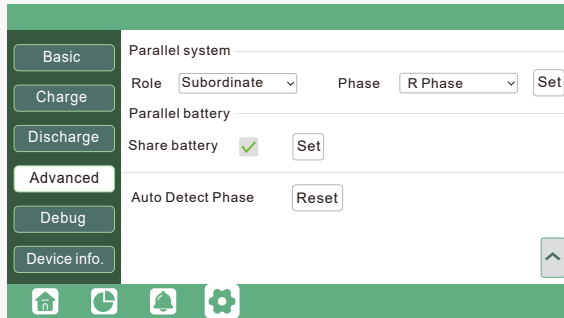

Inv3 setting

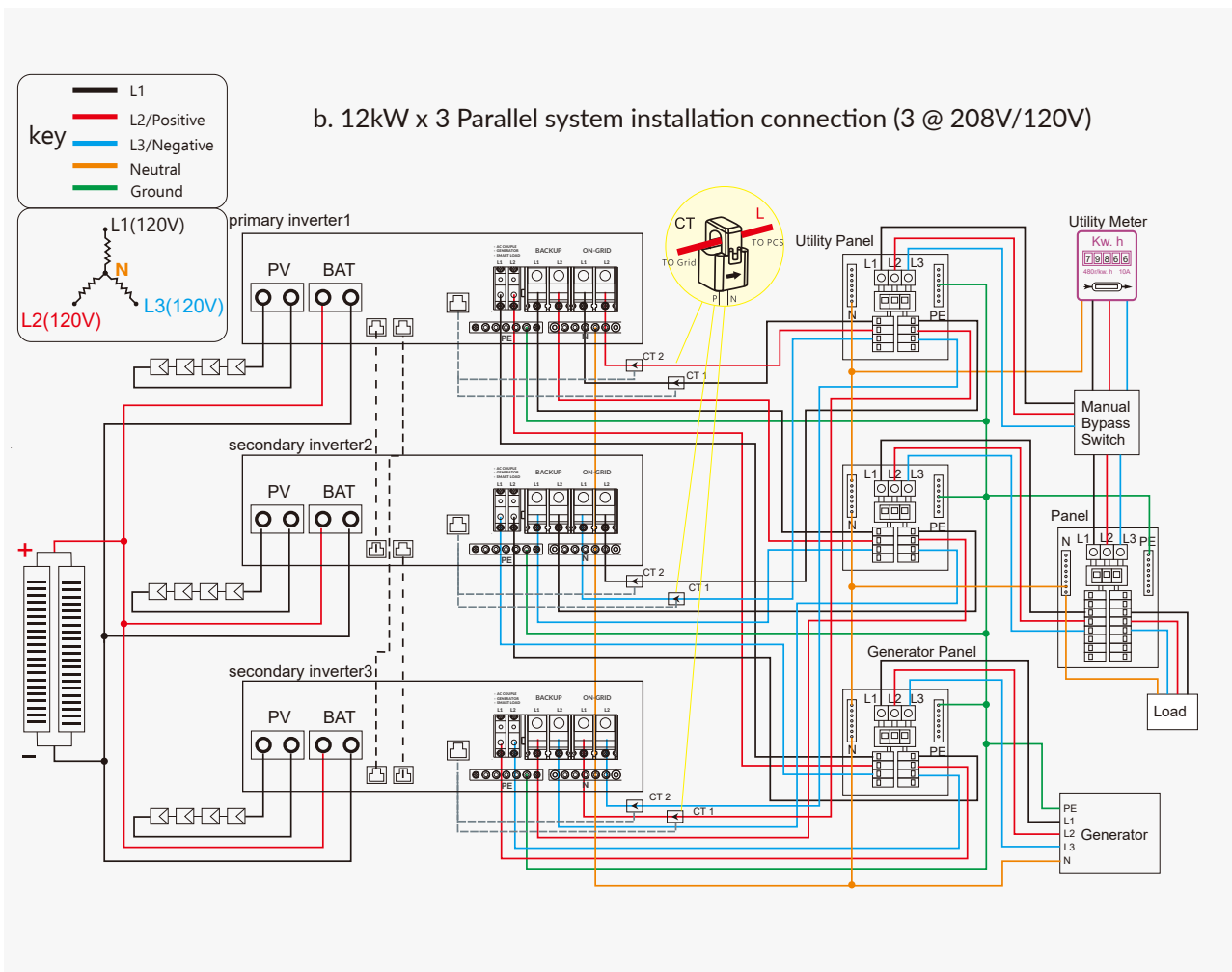
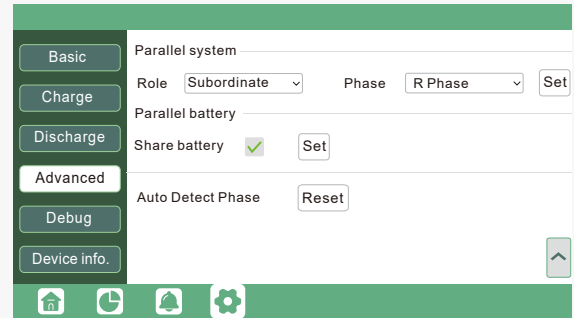

Grid type setting for each inverter

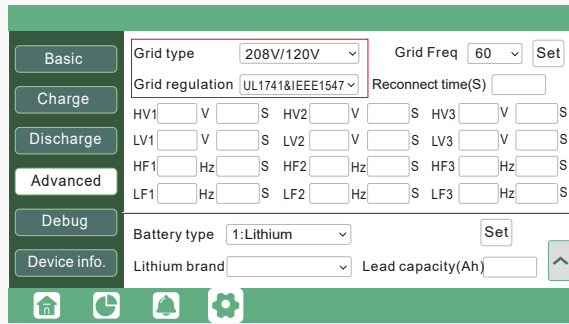

Inv1 setting

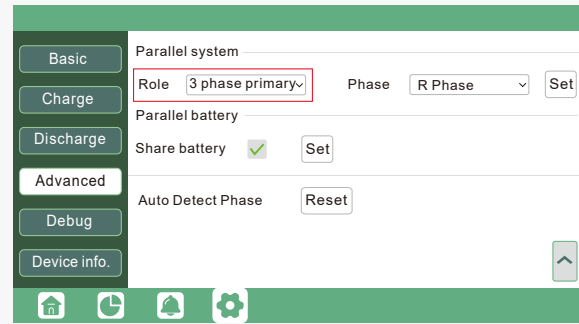

Inv2~5 setting

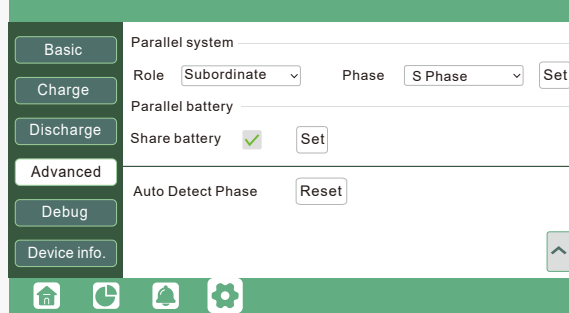

Inv6 setting

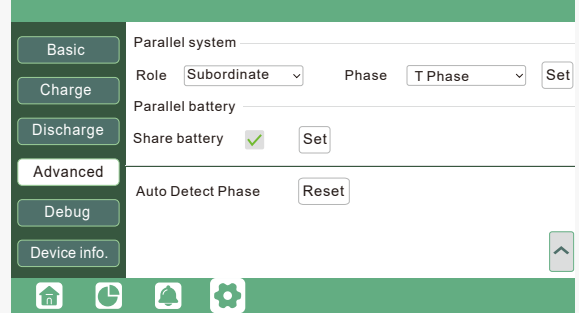

c. 12kW x 2 Parallel system installation connection (2 @ 208V/120V)

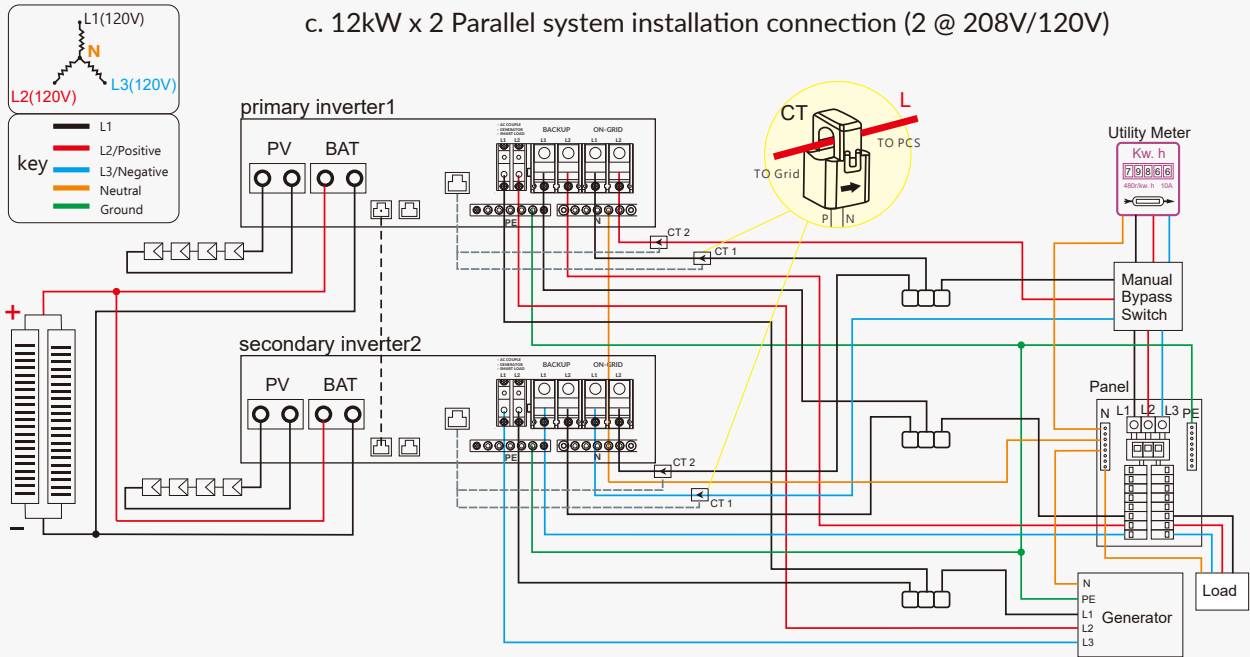

Grid type setting for each inverter

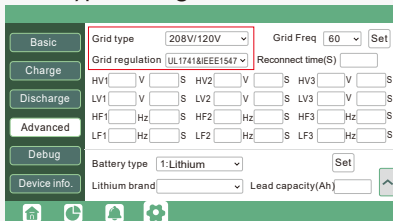

Inv1 setting

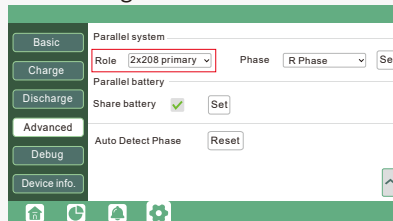

Inv2 setting

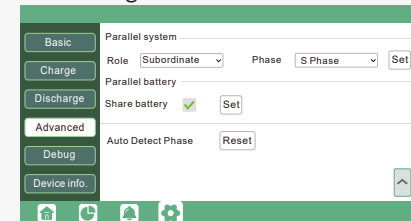

d. 12KW x 2 Parallel system installation connection (2 @ 240V/120V)

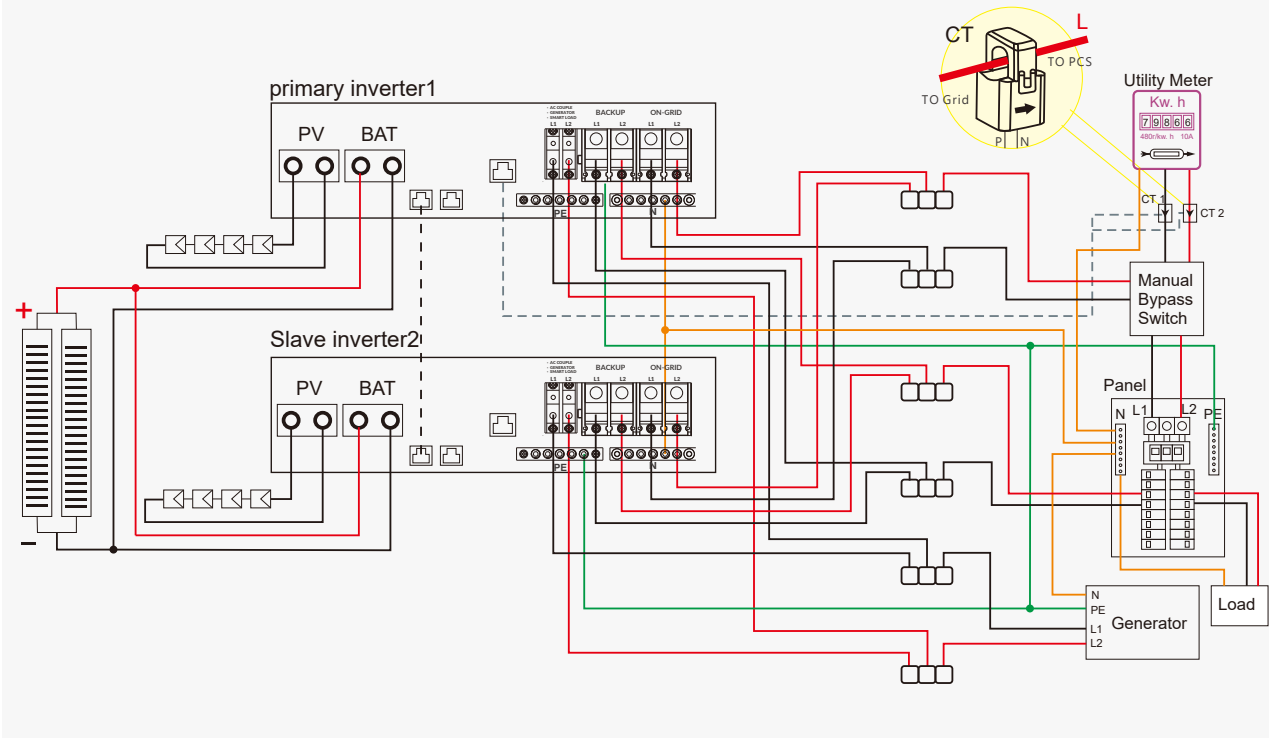

Grid type setting for each inverter

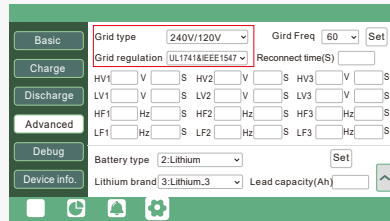

Inv1 setting

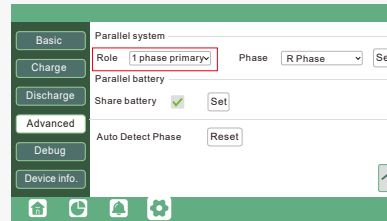

Inv2 setting

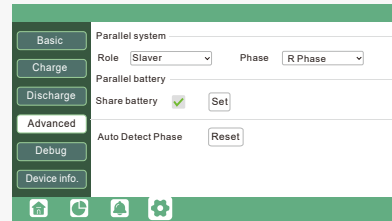

Parallel line(n to 1) The max parallel quantity is 10, so $2 < n < 10$

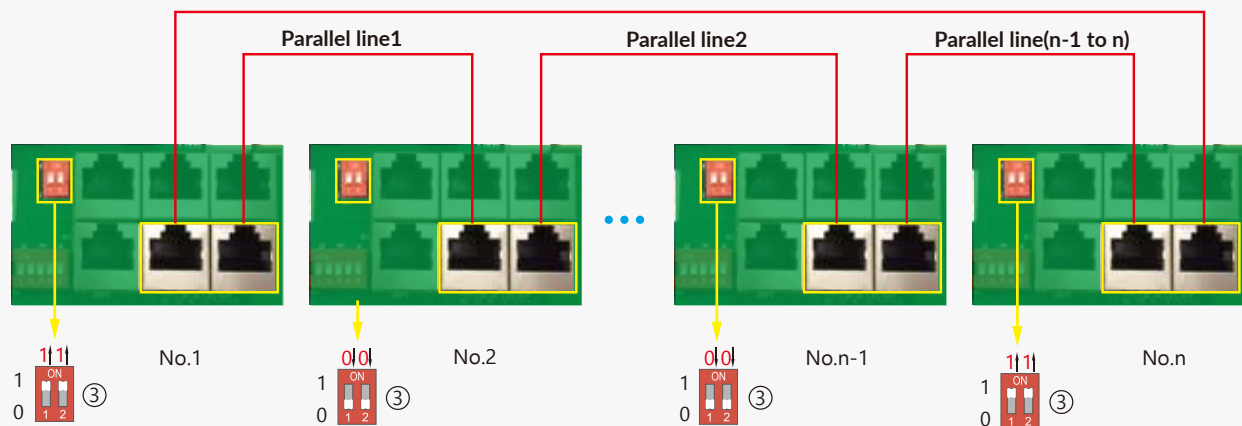

Step 2. Take the parallel cable out of the M Hybrid Inverter box. Perform the wiring as shown below. Toggle ON the CAN communication pin of the first and the last inverters.

Parallel settings in monitoring system

1. Configure monitoring for the system and add all adaptors to one station. Users can log in to access the monitoring system and add adaptors via "Configuration -> Stations -> Equipment management -> Add adaptor".

	Plant name	Installer	End User	Country	Timezone	Daylight saving time	Create date	Action
1	Genesis		Aspergo Install	South Africa	GMT+2	No	2019-03-14	Plant Management
2	Butler Home	Elangeni	johnbutler	South Africa	GMT+2	No	2019-03-25	Plant Management
3	Office			South Africa	GMT+2	No	2019-06-03	Plant Management
4	Cronje Home	Broomhead	cronje	South Africa	GMT+2	No	2019-07-16	Plant Management

2. If the system shares a single M Battery, enable Share Batteries, otherwise disable it.
3. Set the system as parallel group in monitoring system

	Serial number	Status	Solar Power	Charge Power	Discharge Pow	Load	Solar Yielding	Battery Dischar	Feed Energy	Consumption E	Plant name	Parallel	Action
1	0272011008	Normal	228 W	42 W	0 W	182 W	215.3 kWh	39.6 kWh	0 kWh	551.2 kWh	Dragonview	A-1	Parallel
2	0272011011		35 W	32 W	0 W	0 W	158.7 kWh	21.1 kWh	0 kWh	160.5 kWh	Dragonview	A-2	Parallel
3	0272011012		1 kW	129 W	0 W	1 kW	170.3 kWh	49.9 kWh	0 kWh	434.5 kWh	Dragonview	A-3	Parallel
4	0272011017		79 W	48 W	0 W	106 W	99 kWh	85.6 kWh	0 kWh	257.1 kWh	Dragonview	A-4	Parallel

Display of paralleling information

Paralleling info is boxed in red.
 Pnum: 01 - 10, indicating serial number of parallel device unit
 Role: M or S, referring to "primary" inverter and secondary inverter respectively.
 Phase: 1 - 3, in which 1: Phase R, 2: Phase S, and 3: Phase T

! Note:

- Upon wiring the M Hybrid Inverter following the above mentioned steps, please check if the system works properly as per Diagram 8.5 herein before locking the front cover back on. Avoid opening the front cover repeatedly.
- Make sure that the generator is connected to all systems in parallel (if practicable).
- If the PV panels can't be distributed to each inverter averagely, we recommend connecting more PV panels to the primary inverter.
- The values displayed on the M Smart Screen for each inverter are distributed ones for that specific inverter instead of the total of the system.

8.4.2 Wiring between a single M Hybrid Inverter and multiple M Cabinets

Step 1. Prepare the combiner box and cables as per the specified requirements.

- a. Combiner box: Utilize a DC600V/250A combiner copper bar.
- b. Cable:

Current	Sectional area	Diameter	Min. voltage	Tightening torque for cable connection
200A	1/0-2/0AWG(55-70mm ²)	8-9mm	600V	33(N.M)

Step 2. The wiring between a single M Hybrid Inverter and multiple M Cabinets is illustrated in the figure below.

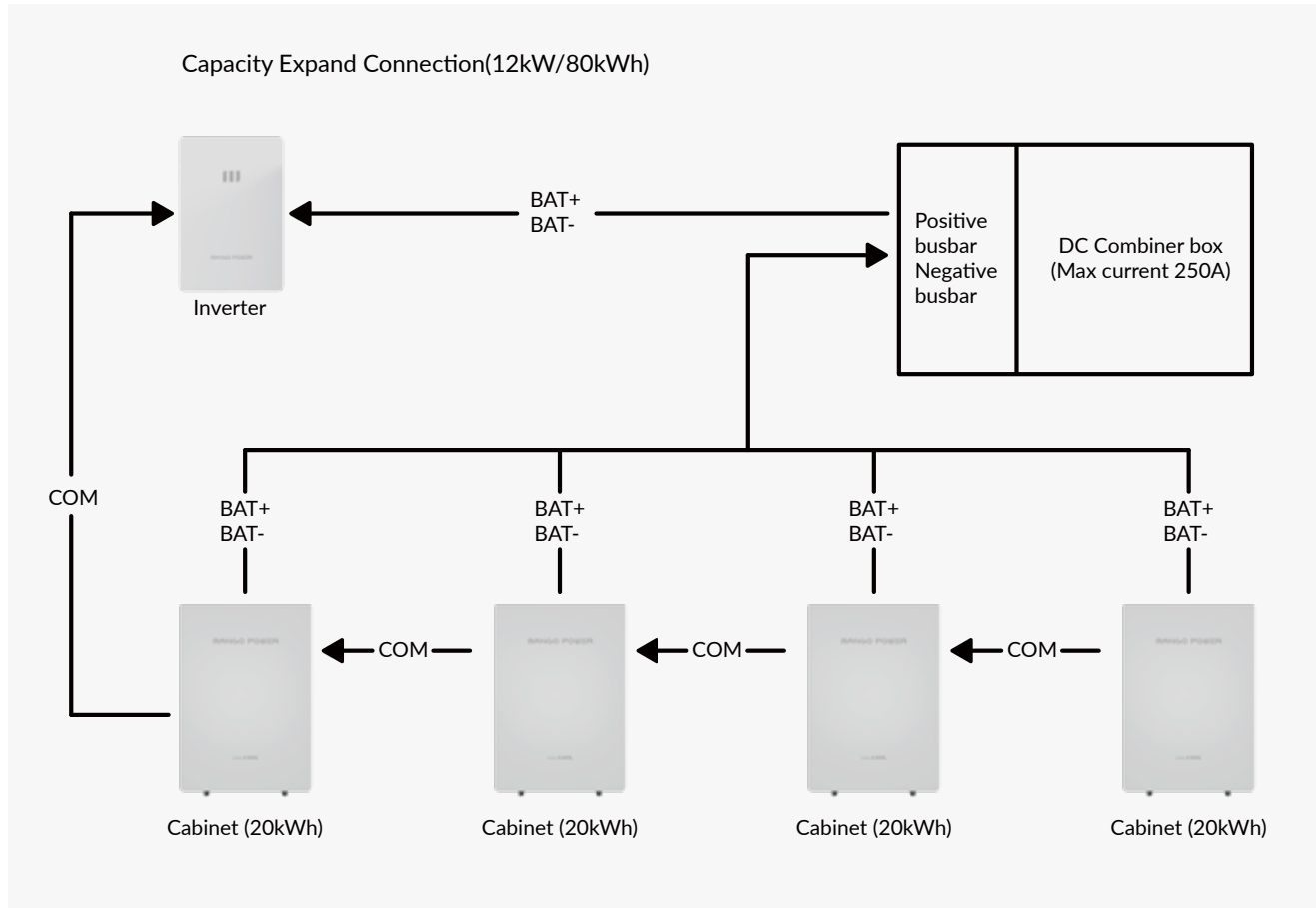

- a. Please refer to chapters 7.1 to 8.3 of the manual for detailed instructions on how to complete the installation and wiring of a single M Hybrid Inverter and a single M Cabinet.
- b. Connect all power lines from the M Cabinet to the combiner box.
- c. Connect the positive and negative busbars in the combiner box to the BAT+ and BAT- terminals of the M Hybrid Inverter, respectively.
- d. After completing the communication part of the first M Cabinet as outlined in Chapter 8.3 of the manual, it still needs to be connected according to the diagram provided below.



e. The communication components of the second and third M Cabinets is shown below

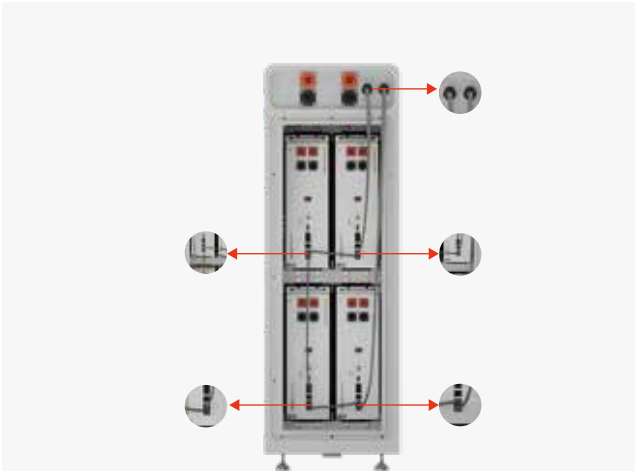

f. The communication components of the fourth M Cabinet is shown below

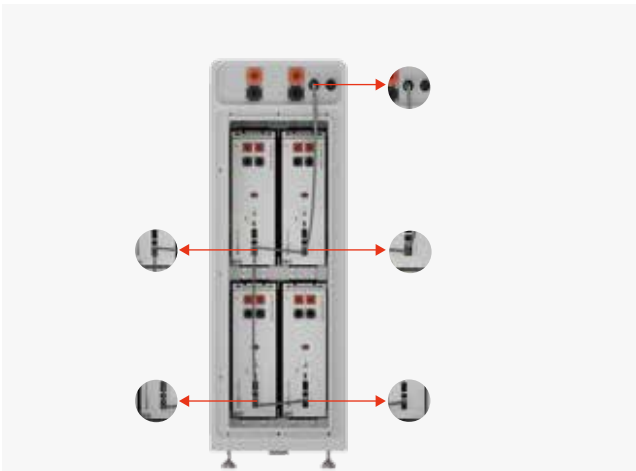

g. Securely block the battery communication interface of the fourth M Cabinet using the seal provided in the package.

h. Connect the inverter communication/battery communication interface of the first M Cabinet to the inverter using the supplied communication cable. Similarly, connect the inverter communication/battery communication interface of the second, third, and fourth units to the corresponding interface of the preceding unit. The battery communication interface should be connected using the provided communication cable.

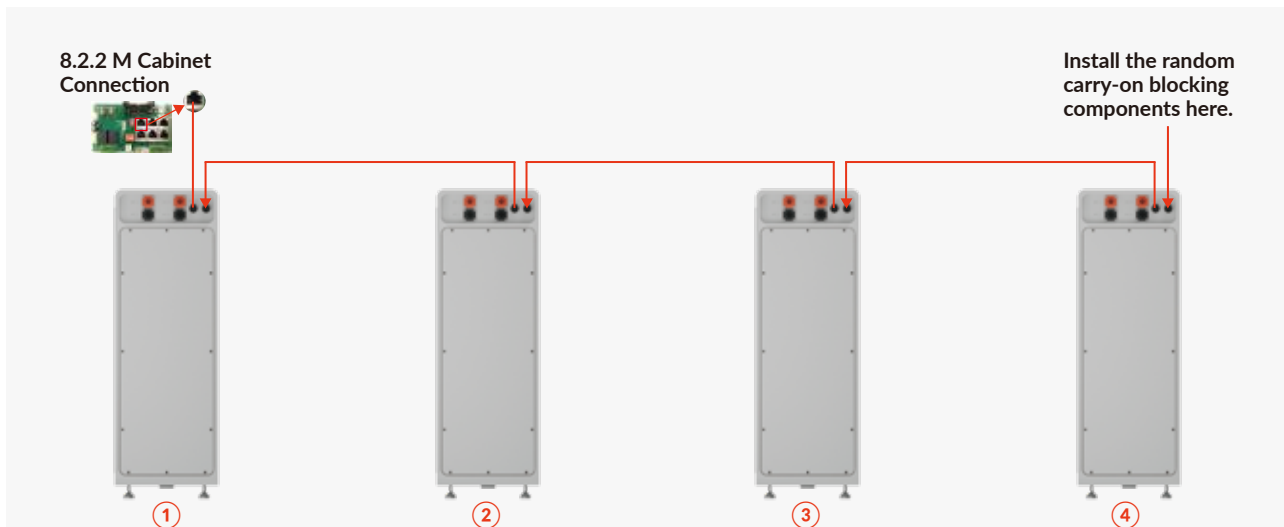

8.4.3 Wiring multiple M Hybrid Inverters to a single M Cabinet

The inverter supports AC coupling connection with the existing grid-interactive solar system. The existing solar system is connected to the inverter's Generator port.

Step 1. Prepare combiner box and cables as per the specifications below.

- a. Combiner box: 240V/300A or 120V/600A or 208V/350A combining copper busbar.
- b. Cables:

Current	Sectional area	Diameter	Min. voltage	Tightening torque for cable connection
100A	3-2AWG(25-35mm ²)	6-7mm	600V	7(N.M)
200A	1/0-2/0AWG(55-70mm ²)	8-9mm	600V	33(N.M)

The wiring arrangement for 10 M Hybrid Inverters and 10 M Cabinets is shown below:

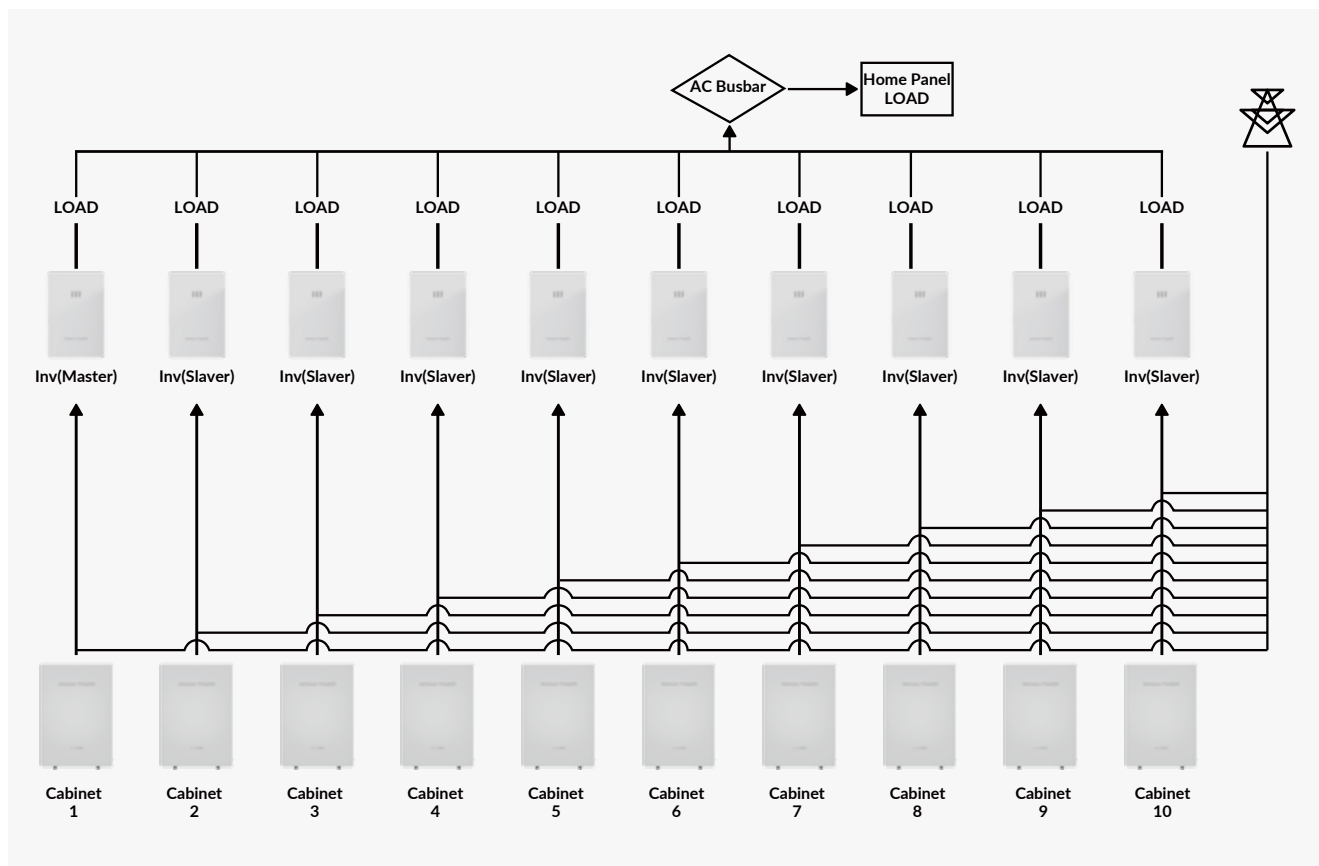

- a. Please follow the steps in 7.1 to 8.3 herein and connect individual M Hybrid Inverters and individual M Cabinets in sequence.
- b. Please follow the steps in 8.4.1 herein and connect multiple M Hybrid Inverters in parallel, and specify primary inverter.
- c. Connect all cables coming out of the inverter BACKUP into the combiner box (on your own based on voltage class).
- d. Have the other end of the combiner box connected to the household distribution box.

8.4.4 Wiring between 10 M Hybrid Inverters and 40 M Cabinets

The wiring procedure on the M Hybrid Inverter side remains consistent with 8.4.3, while the wiring approach on the M Cabinet side follows the guidelines provided in 8.4.2. Material preparation should align with the requirements mentioned in both 8.4.2 and 8.4.3.

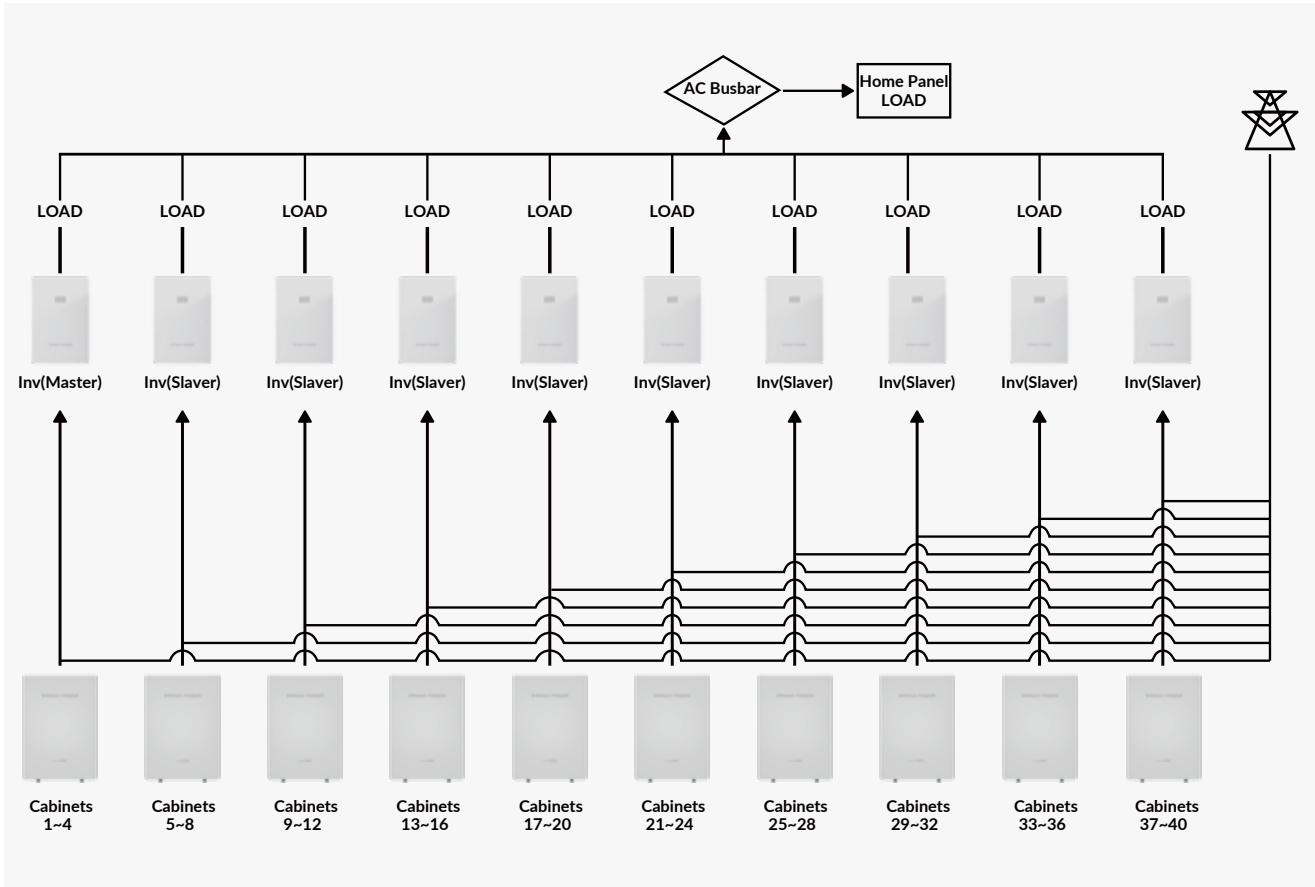

8.5 Direction on System Wiring Confirmation

Wear safety equipment and follow the steps in sections 7.1 to 8.4 of the user manual to complete the wiring of MANGGO POWER M.

8.5.1 System Shutdown Check

Step 1. Visual inspection. Check if cables are subject to any damage and if screws are properly tightened.

Step 2. Check if cables are proper and tightened for PV, Battery, Generator, BACKUP, and On-Grid use.

a. Battery wiring check. Turn the range switch on the multimeter to direct voltage and connect the probes to BAT+ and BAT- in parallel. If the voltage reading falls in 40 - 60V, the wiring is correct.

b. Generator/BACKUP/On-Grid wiring checks. Turn the range switch on the multimeter to alternating voltage, and connect the probes to L1 and L2 in parallel with the Generator/BACKUP/On-Grid. The reading should be zero.

8.5.2 Start-Up Check

Step 1. First, Toggle the “ON/OFF switch” to ON position for all M Batteries. Then, turn on the BATTERY+ Breaker of M Hybrid Inverter. Make sure the voltage of each PV is higher than 120V and turn on the PV.

Step 2. Generator/Backup Load/On-Grid wiring checks. Turn the range switch on the multimeter to alternating voltage, and connect the probes to L1 and L2 in parallel with the Generator/Backup Load /On-Grid. The reading should be $240\text{ V} \pm 25\%$.

Step 3. With Step 1 and 2 working properly, check if the inverter can enter bypass and grid-connection modes as intended.

Step 4. If the normal LED on the M Smart Screen turns green, the wiring is correct.

8.5.3 System Shutdown

Upon confirming wiring, shutdown the system again. Follow the steps below:

Step 1. Turn off the circuit breakers of the household distribution box. <https://dl.mangopower.com/d66783b7-5149-4584-8b2f-94c814>

Step 2. Turn off LOAD Breaker.

Step 3. Turn off the PV switch and BATTERY+ Breaker and wait until the M Smart Screen switches off.

9 Installation and Wiring of the M Smart Screen

After the correct installation of the M Hybrid Inverter, M Cabinet, and M Battery, install the M Smart Screen indoors. Please note that a distance less than 0.5m should be maintained between the M Smart Screen and M Hybrid Inverter.

Step 1. Remove the HDMI on the side of the M Smart Screen and move the M Smart Screen indoors.

Step 2. Drill holes on the selected wall, take out expansion bolts from the box, insert them into the holes, and tighten the bolts. Hang the M Smart Screen base onto the expansion bolts - ensuring that the mounting is steady and reliable to hang the main body of the M Smart Screen onto the base.

Step 3. Drill a 1 inch (25.4mm) hole on the indoor-outdoor partition wall. Thread the HDMI cable through the hole and plug it back into the interface on the side of the M Smart Screen.

Step 4. Take out Type C sealers from the box and plug the hole for HDMI. Wiring is then complete.

10 MANGO POWER APP

MANGO POWER M supports Wi-Fi connection. Please download the MANGO POWER APP from Google Play or the Apple APP Store and sign up with an email account or from a third party account (quick login with Google, Apple or Facebook accounts). MANGO POWER M supports OTA upgrades. Please acquire it at www.mangopower.com. The download URL for App and App user manual is:

<https://dl.mangopower.com/d66783b7-5149-4584-8b2f-94c814881129> , or scan the QR code on the final page.

11 Operation instructions

11.1 Work Modes and Functions

The inverter comes with multiple work modes and functions to fulfill the varying needs of customers. These modes and functions are described below.

11.1.1 Self-Consumption Mode (Default)

In this mode, the order of precedence for power supply to loads: PV > Generator > Batteries > Grid. The order of precedence of supply from solar power generation: Loads > Batteries > Grid.

Applications

Self-consumption mode increases the self-consumption rate of PV power and significantly reduces tariff costs.

Relevant settings

Valid when Charge First, AC Charge, and Forced Discharge are disabled.

Step 1. The wiring diagram is shown below. It is set by default to bypass the switch manually and connect loads to the backup port. When the inverter is faulted, the user can toggle the loads to utility power.

Example

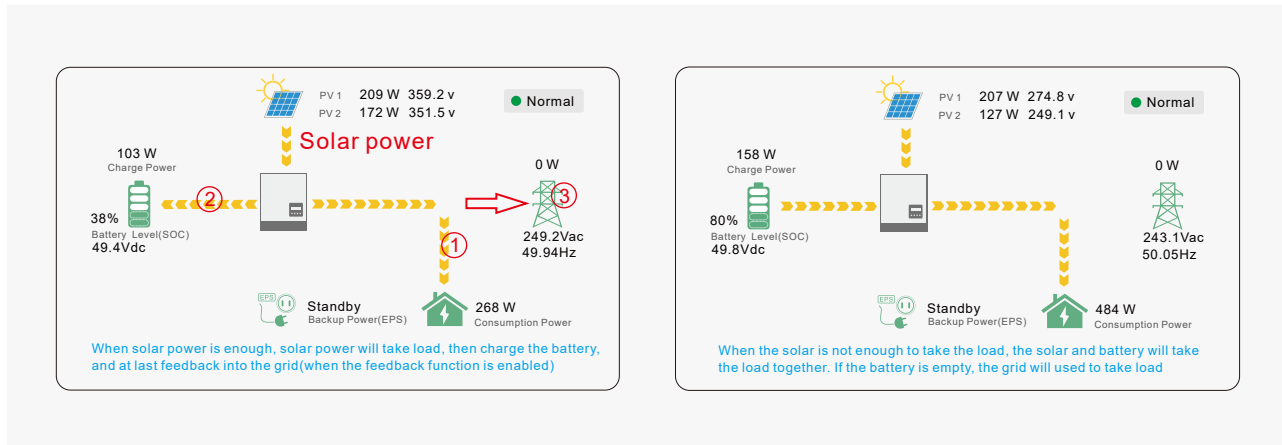

11.1.2 Charge First Mode

In this mode, the order of precedence of supply from solar power generation: Batteries > Loads > Grid. During Charge First mode, the loads utilize power supplied from the grid preferentially. If redundant solar power is available besides charging batteries, such power will be combined with grid power and supplied to loads.

Applications

If the user wishes to charge batteries with solar power, loads will be supplied with grid power.

Relevant settings

Example

Solar power will be used to charge the battery first, if there is extra power, it will be used to take the load.

11.1.3 AC Charge Mode

The user can charge batteries with grid power during low tariff period, and supply power to loads or the grid with batteries during high tariff period.

Applications

When the user has a plan for "Time of Use (TOU)" rate.

Relevant settings

11.1.4 Peak Load Shifting of Grid

This is used to specify the max. power acquired by the inverter from the grid.

Relevant settings

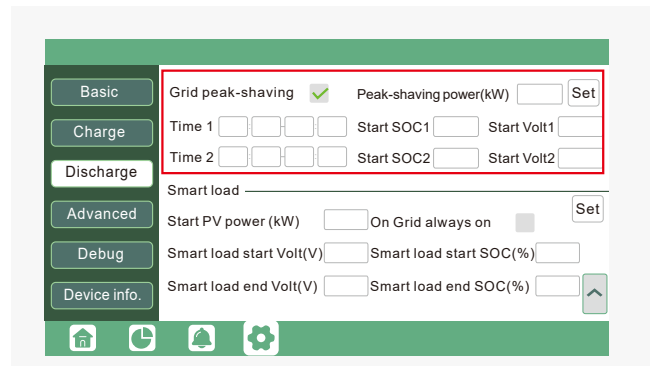

11.1.5 Intelligent Loads

This function is designed to use the generator input as a load connection. If it's enabled, inverters will supply power when the battery SoC and PV power are above the values set by users. For example, with intelligent load activation SoC = 90%, end SoC = 85%, and PV activation power 300 W, it means: When PV power exceeds 300 W and battery system SoC reaches 90%, the port of intelligent loads will be activated automatically and supply power to loads connected to this side. When the battery reaches SoC < 85% or PV power < 300 W, the port of intelligent loads will cease working automatically.

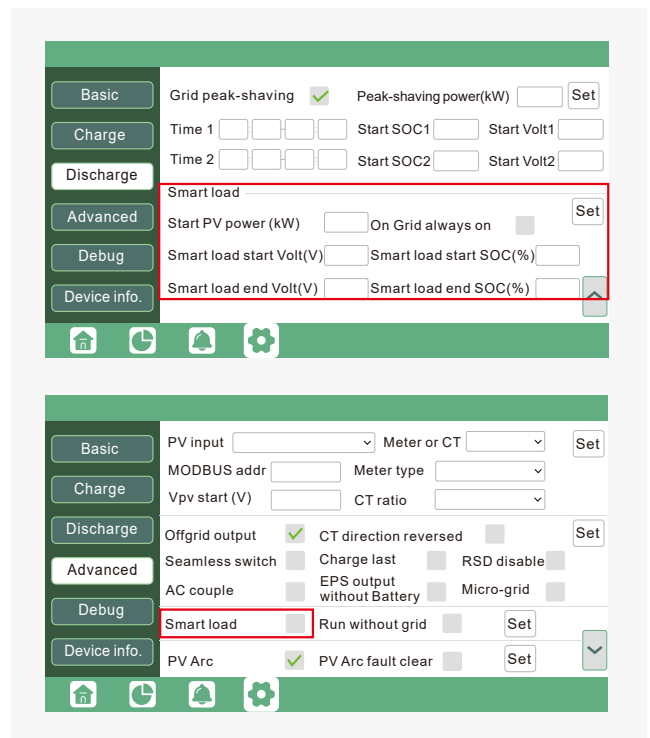

Note:

If you enable intelligent loads, you should disable the connection to the generator, otherwise the equipment will be damaged.

11.2 PV Quick Shutdown

In an emergency, press the quick shutdown button on the left, cut off RSD power, and stop the AC output of inverters. The voltage in PV panels will drop to below 30V within 30 seconds.

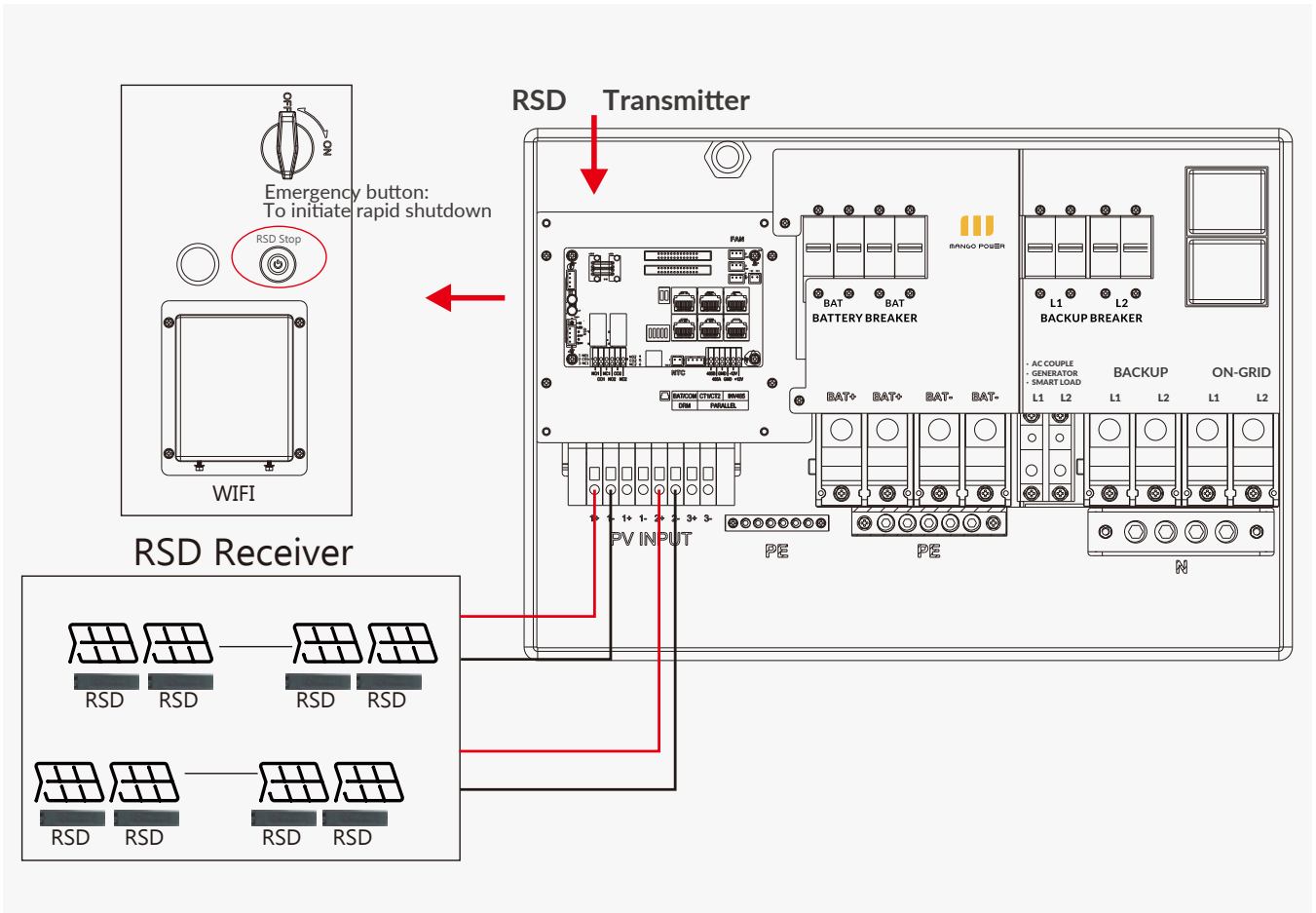

11.3 M Smart Screen

Users can view running states, live power, and daily/accumulated energy info on the accessory M Smart Screen. Apart from the data above, users can also check alarms and failure loggings on the touchscreen to perform troubleshooting.

11.3.1 Check Info, Alarms, and Failure Logs

If the touchscreen is in sleep mode, you can wake it up by tapping the screen which will then show you the homepage. Users can see a system overview and live info of all components - such as battery SoC, battery charge/discharge power, grid input/output power, and load power. On the right of the screen, users can check daily and accumulated solar power data, battery charge/discharge energy, grid input/output energy, load consumption, etc.

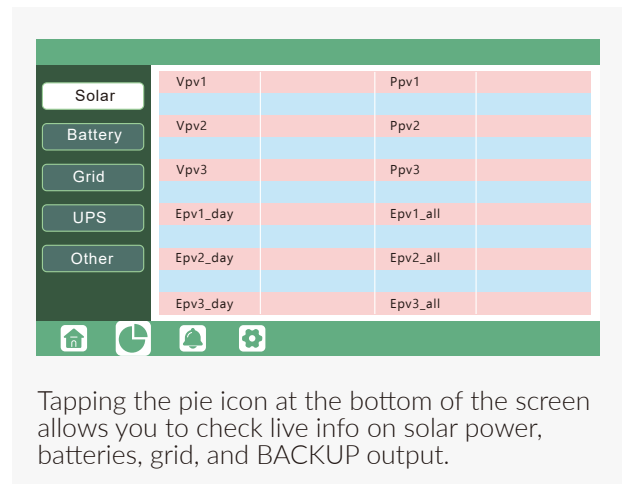
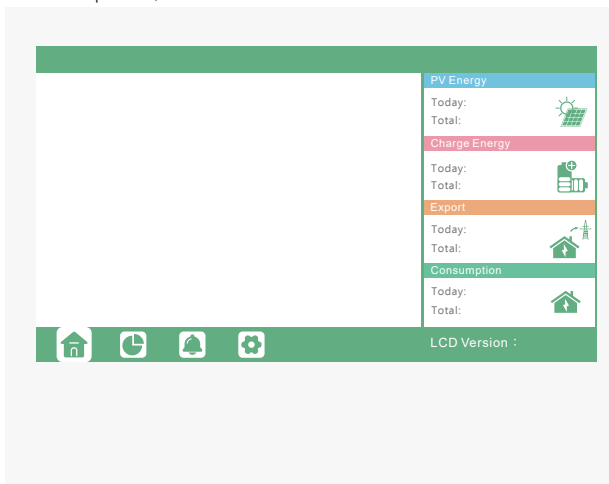

Tapping the pie icon at the bottom of the screen allows you to check live info on solar power, batteries, grid, and BACKUP output.

Faults/Alarm info



Tapping the bell icon at the bottom allows you to check all current and historic faults/alarms on the current page.



11.3.2 Parameter Settings

Tapping the gear icon at the bottom allows you to access parameter settings of inverters.

a. Basic settings

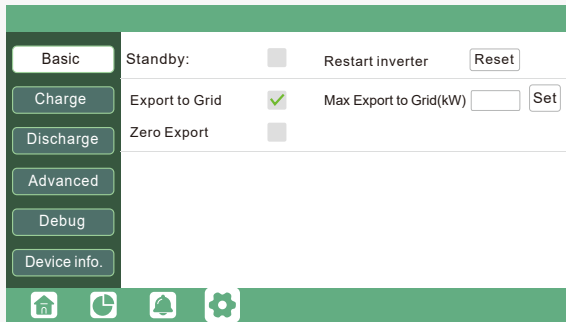

- **Standby:** Used to set the inverter into Normal or Standby state. In Standby state, the inverter ceases charge and discharge as well as feeding solar power to the grid.
- **Restart inverter:** Restart the system, please note the power maybe interrupted when restarted.
- **Feed-in grid:** Used to set zero output. If users don't want to allow external output of solar power, they should disable "Feed-in Grid". If the user's utility meter trips even when only a small amount of solar power is supplied externally, "Fast zero export" may be enabled so that external power supply will be detected every 20 ms with corresponding regulation to effectively avoid any external supply of solar power. If users allow external supply of power, they can enable "Feed-in Grid" and configure it in "Feed-in Power (kW)".

b. Charge settings

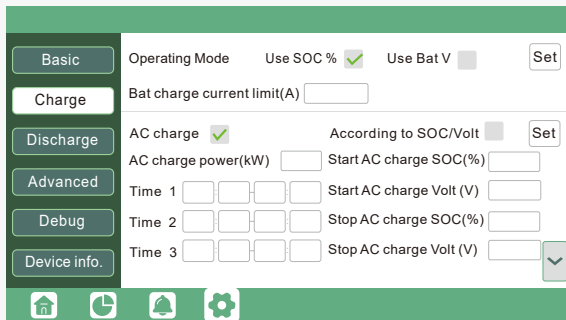

- **Bat charge control:** Used to decide whether to control charge/discharge logics with SoC or BatV based on battery types.
- **Bat charge current limit (A):** Used to specify the max. charge current
- **AC charge:** This configures charge with utility power. If users wish to charge batteries with grid power, they can enable "AC Charge", specify periods and power of AC charge to limit utility charge power, and set the target SoC of utility power charge through "Stop AC Charge SOC(%)". "Stop AC Volt(V)" is used to set target battery voltage for utility power charge

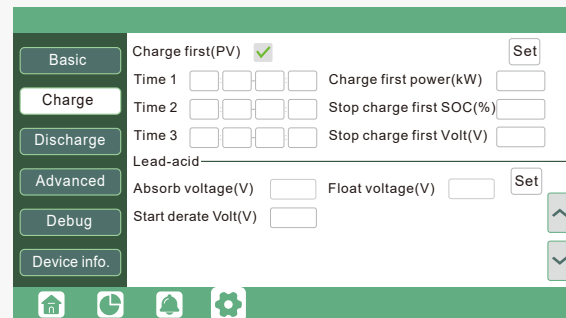

- **Charge first (PV):** This configures charge with PV power. If you enable Charge First, PV power will be used to charge batteries preferentially. You can specify periods of PV charge, power of charge first (kW), limit PV charge power, and set the target SoC of Charge First with PV power through "Charge first SOC(%)". "Charge first Volt (V)" is used to set target battery voltage for PV power charge.

Generator:

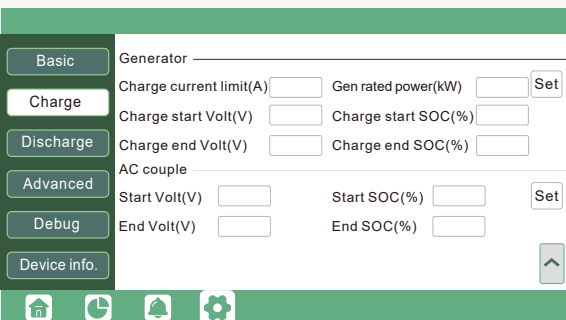

- **Charge current limit (A):** Used to set max. battery charge current from the generator. The generator will perform charging based on Charge Start Volt./SoC settings and ends it when the actual voltage or SoC of the battery reaches Charge End Volt./SoC settings.
- **Gen rated power (kW):** The inverter comes with a peak load shifting feature. You can specify the peak load shifting power (W) for the generator if needed.

c. Discharge settings

- **Bat discharge control:** You can choose “Use SOC %” or “Use Bat V” to control the discharge of batteries.
- **Discharge current limit (A):** Used to set the max. discharge current of batteries.
- **Discharge start power (W):** The lower limit of this is 50. When the inverter detects a power input greater than that, the battery will start discharging, otherwise it will remain standby.
- **On-grid EOD(%) and off-grid EOD (%) /On-grid Cut-off(V) and off-grid Cut-off (V):** The end of discharge SoC/ cut-off voltage under on-grid/off-grid conditions.
- **Forced discharge:** This forces batteries to discharge in specific periods. In those periods, the inverter will force the battery to discharge at the value set in “discharge power” until battery SoC or voltage reaches the specified “Stop discharge” values.

d. Advanced settings

Advanced settings are mainly intended for use by installation personnel after installation.

- **Grid type:** You can select 240/120V or 220/108V.
- **Battery type:** No battery, lead-acid batteries, or lithium-ion batteries.
- If you select lithium-ion batteries, please choose their brand from the drop-down menu.

The CT ratios supported are 1,000: 1, 2,000: 1, and 3,000: 1. The CT ratio is 3,000: 1 by default. If you are using a third-party CT, please ensure its CT ratio is one of 1,000: 1, 2,000: 1, and 3,000: 1, and set it here.

- **Meter type:** Please perform settings here according to the actual meter installed.
- **Off-Grid Output:** For users to decide if the inverter supply backup power goes on when there's a grid power outage. If users want the loads to be transferred to the inverter backup power smoothly, they must enable the “Seamless switch” option. If the customer has not installed batteries but still wants to use the inverter backup power with a connection to the PV panels alone, the “PV Grid Off” option should be chosen. This will allow the PV panels to supply power to loads during grid failure or loadshedding. Micro-grid: You only have to set this when the generator is connected to the grid connection port of the inverter. If this is enabled, the inverter will charge the batteries with AC power, and will not output any power through its grid connection port when the port is using AC power.
- **Charge last:** This applies when the user wants to use solar power in the sequence of “Loads - Grid power supply - Battery charge”.
- **CT direction reversed:** If the CT is installed reversely, installation personnel can select this as a solution without doing any reconnection.

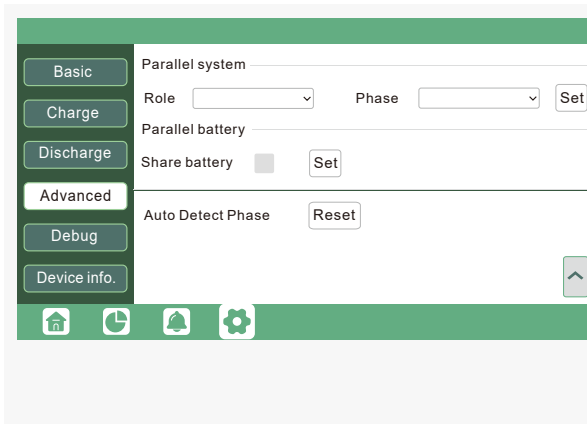

- **Role:** Used to set the role of a parallel system. Set as 1-phased primary inverter by default. In a parallel system, only one inverter can be set as the primary while the rest should be set as secondary.
- **Phase:** Used to set phase code of ESP output. The system will detect the phase sequence of the inverter automatically - which is the same as the grid power supply connected - and display it on the Smart Screen when connected to the grid.
- **Share battery:** When the inverter is connected as a parallel system, all inverters share batteries. On this account, "Share Battery" should be enabled as well.

Note:

- All the setting work of the parallel inverters should be carried out on standby or fault modes.
- Please check on the M Smart Screen and make sure each and every inverter in the parallel system shares the same settings.

11.4 Start and Stop Inverters

11.4.1 Start Inverters

- **Step 1.** Start the battery system first: Turn on BAT+ Breaker.
- **Step 2.** Make sure that the PV voltage of the PV strings is higher than 120V and check whether the inverter is on PV charge mode or PV charge backup power mode.
- **Step 3.** With Step 1 and 2 carried out correctly, connect the grid power or generator circuit breaker and check if the inverter can enter bypass and grid-connection modes as intended.

11.4.2 Stop Inverters

Danger: Do not disconnect the power of the batteries, PV, and AC input with loads. In case of an emergency, press the emergency stop button on the left, as illustrated below.



To stop an inverter, follow the steps below:

- **Step 1.** Disconnect the circuit breakers of the household distribution box.
- **Step 2.** Disconnect the LOAD Breaker.
- **Step 3.** Disconnect the switch then the BATTERY+ Breaker and wait until the M Smart Screen switches off.

12 Troubleshooting and Maintenance

12.1 Regular Maintenance

Maintenance of inverters

- Inspect inverters every 6 or 12 months for any signs of damage in cables, fixings, terminals, and the general inverter device.
- Inspect inverters every 6 months for anomalies in operation, heat, or noise parameters.

- Inspect inverters every 6 months to ensure that the radiator of the inverters is not covered by anything. If it is, stop the inverter and clean its radiator.

Battery maintenance

- Do dust cleaning and battery performance checks every month to ensure the operability of the product.
- Scrapped products should be recycled immediately by the specified qualified vendor instead of being discarded at will and risking safety hazards or severe environmental contamination.
- Batteries in long-term storage should be charged to 50% - 60% SoC every 6 months.

12.2 M Battery Troubleshooting

If the M Battery displays any warnings or faults, users can perform troubleshooting based on the states of indicator lamps and the buzzer.

12.2.1 Notes on indicator lamps:

Status	Normal/Alarm/Protection	ON/OFF	RUN	ALM	SoC indicator LED						Remarks
		•	•	•	•	•	•	•	•	•	
Shutdown	Sleep	Off	Off	Off	Off	Off	Off	Off	Off	Off	All off
Standby	Normal	On	Flash 1	Off	Based on SoC indication						Standby state
	Alarm	On	Flash 1	Flash 3	Based on SoC indication						Module LV
Charging	Normal	On	On	Off	Based on SoC indication (max. SoC indication LED Flash 2)						LED flashes (Flash 2) on max. SoC. ALM doesn't flash on overcharge alarm
	Alarm	On	On	Flash 3	Based on SoC indication						
	Overcharge protection	On	On	Off	On	On	On	On	On	On	No grid power, indicator lamp toggled to standby state
	Temperature/ overcurrent/ failure protection	On	Off	On	Off	Off	Off	Off	Off	Off	Stop charging
Discharging	Normal	On	Flash 3	Off	Based on SoC indication						
	Alarm	On	Flash 3	Flash 3	Based on SoC indication						
	Undervoltage protection	On	Off	Off	Off	Off	Off	Off	Off	Off	Stop discharging
	Temperature, over current, short circuit, reverse connection, failure protection	On	Off	On	Off	Off	Off	Off	Off	Off	Stop discharging
Discharging		Off	Off	Off	Off	Off	Off	Off	Off	Off	Stop charging/discharging

12.2.2 Troubleshooting

Serial No.	Fault Phenomenon	Analysis of Causes	Solutions
1	No DC output after startup	Over-discharge protection due to low battery voltage	Carry out charging
2	No working of the indicating lamp after startup	BMS is in dormant state	Restart using the Reset Switch
3	Indicating insufficient electric quantity	Too low charging voltage	Adjust the floating charge voltage of the switching power supply to the required parameters
4	Short power supply time	The battery pack is not full charged	Check the charging voltage, current and other parameters of the switching power supply
5	Unstable output voltage after startup	BMS is interrupted	Restart using the Reset Switch
6	Communication failure	Problems in communication line	Check the address setting of the address switch, ports and lines

! Note:

- The buzzer is designed to be enabled or disabled through the primary computer. It is disabled by default on shipment.
- In case of a fault, the buzzer will sound for 0.25s in every 1s. In case of a protection notice, it buzzes for 0.25s in every 2s (excluding overvoltage protection). In case of an alarm, it buzzes for 0.25s in every 3s (excluding overvoltage protection).

Notes on reset button (RST): When BMS is in sleep mode, press and hold the button for 3 - 6s, the guard is then





- activated and the LED indicator lamps will light up for 0.5s in sequence from "RUN". When BMS is active, press and hold the button for 3 - 6s, the guard will then sleep and the LED indicator lamps will light up for 0.5s in sequence from Min. SoC. When BMS is in sleep mode, press and hold the button for 6 - 10s, the guard is then reset and all the LED indicator lamps will light up simultaneously for 1.5s.

Upon resetting, the BMS still reserves the parameters and functions set by the primary computer. If you wish to restore the original parameters, you can do it through the "Restore defaults" option on the primary computer. However, the operation records and stored data (e.g. SoC, cycles, protection records, etc.) will remain unchanged.

12.3 Troubleshooting According to the M Smart Screen

If the M Hybrid Inverter displays any warnings or faults, users can perform troubleshooting based on the state of the LEDs and the alarm/fault info on the Smart Screen.

12.3.1 States Indicated by the M Hybrid Inverter LEDs

LED	Indication	Remarks	Suggestions
Green LED	On 	Normal	
	Flash 	Firmware is upgrading	Wait for the upgrade to finish
Yellow LED	On 	Warning. The inverter is working	Troubleshooting required
Red LED	On 	Fault. The inverter stopped working	Troubleshooting required

12.3.2 Faults Display on the M Smart Screen

If the dot on the left of a fault entry is red, it means this fault is current. If the dot is gray, it means that this fault doesn't exist anymore.

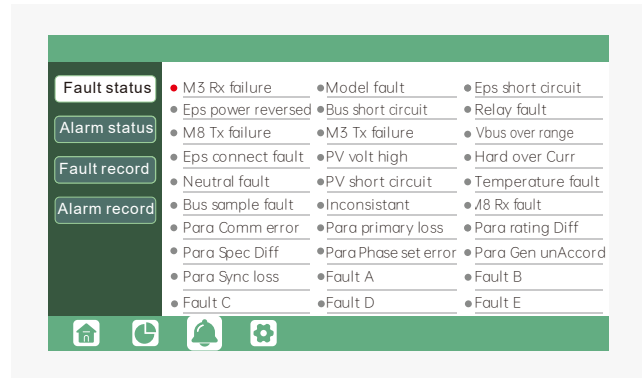

Common faults and corresponding solutions are as follows:

Fault	Meaning	Troubleshooting
M3 Rx failure	M3 microprocessor fails to receive data from DSP	Restart inverter, if the error still exists, contact your supplier.
Model fault	Incorrect model value	
BACKUP short circuit	Inverter detected short-circuit on BACKUP output terminals	1. Check if the L1, L2 and N wires are connected correctly at inverter BACKUP LOAD output port; 2. Disconnect the LOAD breaker to see if fault remains. If fault persists, contact your supplier.
BACKUP power reversed	Inverter detected power flowing into BACKUP port	Restart inverter, if the error still exists, contact your supplier.
Bus short circuit	DC Bus is short circuited	
Relay fault	Relay abnormal	
M8 Tx failure	DSP fails to receive data from M8 microprocessor	
M3 Tx failure	DSP fails to receive data from M3 microprocessor	Please check if the PV string voltage is within the inverter specification. If string voltage is within range and this fault still appears, contact your supplier.
Vbus over range	DC Bus voltage too high	
BACKUP connect fault	BACKUP LOAD port and grid port are connected mixed up	Check if the wires on the BACKUP LOAD port and grid port are connected correctly. If the error still exists, contact your supplier.

PV volt high	PV voltage is too high	Please check if the PV string voltage is within the inverter specification. If string voltage is within range and this fault still appears, contact your supplier.
Hard over curr	Hardware level over current protection triggered	Restart inverter. If the error still exists, contact your supplier.
Neutral fault	Voltage between N and PE is greater than 30V	Check if the neutral wire is connected correctly
PV short circuit	Short circuit detected on PV input	Disconnect all PV strings from the inverter. If the error persists, contact your supplier.
Temperature fault	Heat sink temperature too high	Install the inverter in a place with good ventilation and no direct sunlight. If the installation site is okay, please check if the NTC connector inside the inverter is loose.
Bus sample fault	Inverter detected DC bus voltage lower than PV input voltage	Restart inverter. If the error still exists, contact your supplier.
Inconsistent	Sampled grid voltage values of DSP and M8 microprocessor are inconsistent	
M8 Rx fault	M8 microprocessor fails to receive data from DSP	
Para Comm error	Parallel communication abnormal	1.Please check if the connection of the parallel cable is loose and connect it correctly 2.Please check and make sure the PIN status of CAN communication cable from the first to the end inverter is correct.
Para primary loss	No primary in the Parallel system	1.If a primary has been configured in the system, the fault will be automatically removed after the primary works. If so, you can ignore it. 2.If a "master" has not been configured in the system, and there are only secondary in the system, please set the primary first. Note: For single unit running systems, the role of the inverter should be set as "1 phase primary"
Para rating Diff	Rated power of parallel inverters are inconsistent	Please confirm that the rated power of all inverters are the same or contact servicing to confirm.
Para Phase set error	Incorrect setting of phase in parallel	Please confirm that the wiring of the parallel system is correct first. In this case, connect each inverter to the grid. The system will automatically detect the phase sequence and the fault will be automatically resolved.
Para Gen un Accord	Inconsistent generator connect in parallel	Some inverters are connected to generators, some are not. please confirm that all inverters in parallel are connected to generators together or none of them are connected to generators
Para sync loss	Parallel inverter fault	Restart inverters. If the error still exists, contact your supplier.

12.3.3 Alarms Displayed on the M Smart Screen

If the dot on the left of a fault entry is yellow, it means this fault is current. If the dot is gray, it means this fault doesn't exist anymore.

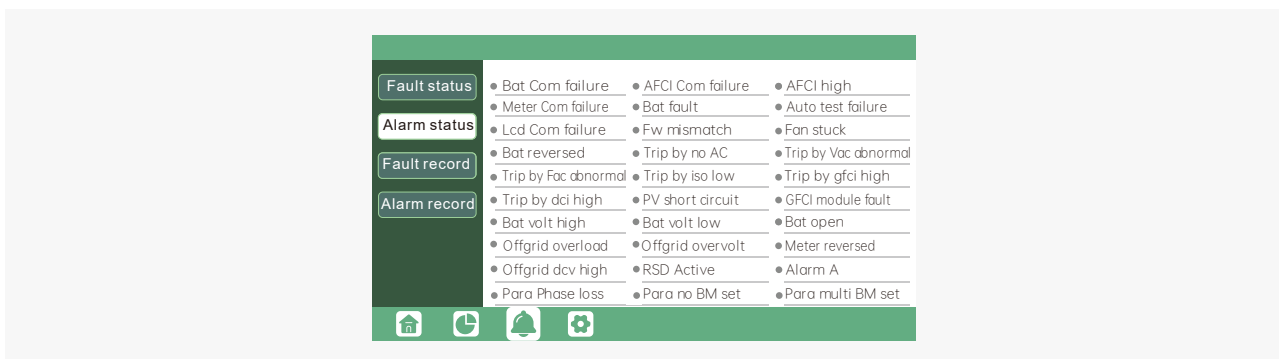

- Inspect inverters every 6 months for anomalies in operation, heat, or noise parameters.
- Inspect inverters every 6 months to ensure that the radiator of the inverters is not covered by anything. If it is, stop the inverter and clean its radiator.

Meanings of faults and corresponding solutions are as follows:

Alarm	Meaning	Troubleshooting
Bat com failure	Inverter fails to communicate with battery	Check if the communication cable is correctly installed and if you have chosen the correct battery brand on the M Smart Screen. If all is correct but this error persists, please contact your supplier.
AFCI com failure	Inverter fails to communicate with AFCI module	Restart inverter. If the error persists, contact your supplier.
AFCI high	PV arc fault is detected	Check each PV string for correct open circuit voltage and short circuit current. If the PV strings are in good condition, please clear the fault on the M Smart Screen.
Meter com failure	PV arc fault is detected	1. Check if the communication cable is connected correctly and in good condition. 2. Restart inverter. If the fault persists, contact your supplier
Bat Fault	Inverter fails to communicate with the meter	1. Check the battery communication cable for the correct pinout on both the inverter and battery. 2. Check if you have chosen an incorrect battery brand. 3. Check if there is a fault on the battery's indicator. If there is a fault, please contact your battery supplier.
Auto test failure	Auto test failed	Only applied to Italian model
LCD com failure	M Smart Screen fails to communicate with M3 microprocessor	Restart inverter. If fault still exists, contact your supplier.
Fwm mismatch	Firmware version mismatch between the microprocessors	
Fan stuck	Cooling fan(s) are stuck	
Trip by gfcI high	Inverter detected leakage current on AC side	1. Check if there is a ground fault on the grid and load side. 2. Restart inverter. If the fault remains, contact your supplier.
Trip by dci high	Inverter detected high DC injection current on grid port	Restart inverter. If the fault remains, contact your supplier.
PV short circuit	Inverter detected short circuited PV input	1. Check if each PV string is connected correctly. 2. Restart inverter. If the fault remains, contact your supplier.
GFCI module fault	GFCI module is abnormal	Restart inverter. If fault still exists, contact your supplier
Bat volt high	Battery voltage too high	Check if battery voltage exceeds 59.9V, battery voltage should be within inverter specifications.
Bat volt low	Battery voltage too low	Check if the battery voltage is under 40V, battery voltage should be within inverter specifications.
Bat open	Battery is disconnected from inverter	Check battery breaker or battery fuse.
Off grid overload	Overload on BACKUP LOAD port	Check if load power on the inverter EPS port is within inverter specifications.
Off grid overvoltage	BACKUP voltage is too high	Restart inverter. If fault still exists, contact your supplier
Meter reversed	Meter is connected reversely	Check if the meter communication cable is connected correctly on the inverter and meter side.
Off grid dcv high	High DC voltage component on EPS output when running off-grid	Restart inverter. If fault still exists, contact your supplier.
RSD Active	Rapid shutdown activated	Check if the RSD switch is pressed.

Para phase loss	Phase loss in parallel system	Please confirm that the wiring of the inverter is correct. If the primary is set to 3 Phase primary, the number of parallel inverters needs to be ≥ 3 . (And the grid input of each inverter should be connected with Grid L1, L2, L3 rightly). If the primary is set to 2x 208 primary, the number of parallel inverters needs to be ≥ 2 . (And the grid input of each inverter should be connected with Grid L1, L2, L3 rightly)
Para no BM set	primary isn't set in the parallel system	Please set one of the inverters in the parallel system as the primary.
Para multi BM set	Multiple primary have been set in the parallel system	There are at least two inverters set as primary in the parallel system, please keep one primary and the other set as secondary

12.4 Replacement of Inverter Fan

We recommend checking and cleaning the fan every 6 months. If the fan is problematic, replace it as illustrated below. Shut down all systems and wait 5 minutes before dismantling the inverter.

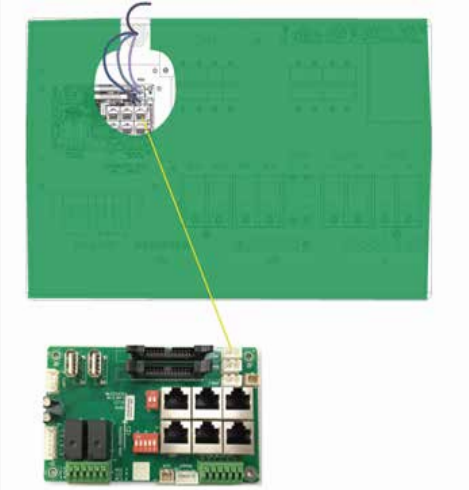

- a. Open wiring cover
- b. Pull out the fan wires
- c. Loosen and remove screws

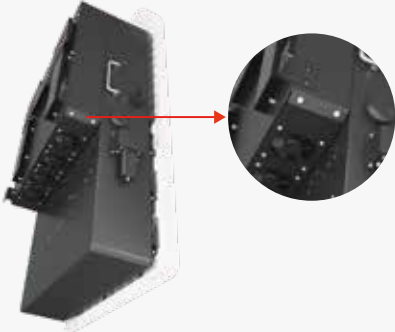

d. Remove fasteners of the fan

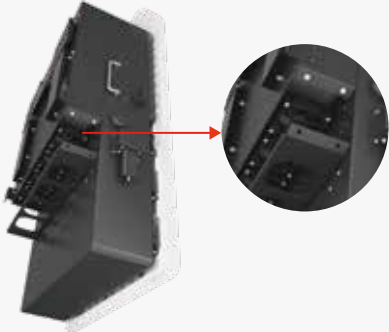

- e. Loosen waterproof connector
- f. Remove and replace the fan
- g. With a new fan installed, follow the steps above backwards

13 Appendix: Technical Data

13.1 Remote start-up/stop of the inverter and alteration of parameter settings

Please refer to the user manual of MANGO POWER APP. URL to download App user manual:

<https://www.mangopower.com/us/support/download/index>, or scan the QR code on the final page.

13.2 Set parameters as per Rule21

13.2.1 Enter service setting

Parameter Name	Default Value	Minimum Adjustable Range	Maximum Adjustable Range
Permit service	Enable	NA	NA
Applicable voltage low	91.7%Vnom	91.7%Vnom	91.7%Vnom
Applicable voltage high	105%Vnom	105%Vnom	106%Vnom
Applicable frequency low	59.5Hz	59.0Hz	59.9Hz
Applicable frequency high	60.1Hz	60.1Hz	61.0Hz
Connection delay time	300s	1s	600s
Reconnection delay time	300s	1s	600s
Ramp rate	20%Pn/min	6000%Pn/min	6%Pn/min

Ramp rate: When normal startup, the output power rise is 1%~100%, the maximum output current/ section is adjustable

13.2.2 High Voltage and Low Voltage Trip

Required settings in accordance with UL 1741 SA	Parameter Name	Default Value	Minimum Adjustable Range	Maximum Adjustable Range
High voltage2 HF2	Grid volt Limit2 High(V)	120%Vnom	Fixed as 120%Vnom	Fixed as 120%Vnom
	Grid volt Limit2 High Time	160ms	Fixed as 160 ms	Fixed as 160 ms
High voltage1 HV1	Grid volt Limit1 High(V)	110%Vnom	110%Vnom	120%Vnom
	Grid volt Limit1 High Time	13s	1s	13s
Low voltage1 LV1	Grid volt Limit1 Low(V)	88%Vnom	0%Vnom	88%Vnom
	Grid volt Limit1 Low Time	21s	2s	50s
Low voltage2 LV2	Grid volt Limit2 Low(V)	50%Vnom	0%Vnom	50%Vnom
	Grid volt Limit2 Low Time	2s	160ms	21s

13.2.3 High Frequency and Low Frequency Trip

Required settings in accordance with UL 1741 SA	Parameter Name	Default Value	Minimum Adjustable Range	Maximum Adjustable Range
High Frequency2 HF2	Grid Freq Limit2 High(V)	62.0Hz	61.8Hz	66.0Hz
	Grid Freq Limit2 High Time	160ms	160ms	1000s
High Frequency1 HF1	Grid Freq Limit1 High(V)	61.2Hz	61.0Hz	66.0Hz
	Grid Freq Limit1 High Time	300s	180s	1000s
Low Frequency1 LF1	Grid Freq Limit1 Low(V)	58.5Hz	50.0Hz	59.0Hz
	Grid Freq Limit1 Low Time	300s	180	1000s
Low Frequency2 LF2	Grid Freq Limit2 Low(V)	56.5Hz	50.0Hz	57.0Hz
	Grid Freq Limit2 Low Time	160ms	160ms	1000s

! Note:

When setting the protection time, it needs to be converted into the number of cycles of the corresponding frequency.

13.2.4 Specified Power Factor (SPF)

The reactive power is controlled as a function if a specified power factor $\cos\phi$

Parameter Name	Default Value	Minimum Adjustable Range	Maximum Adjustable Range
Constant Power Factor Mode	Disable	NA	NA
Under-excited/Over-excited	Under-excited	Under-excited	Under-excited
Constant Power Factor	1	0.8	1

Note:

Use the selected method to set Under-excited/Over-excited.

13.2.5 Voltage / Var Mode (Q(V))

The reactive power is controlled as a function of the grid voltage. The parameterize-action is carried out by means of a reactive power/voltage characteristic curve. The absolute value of Q1 and Q4 are the same.

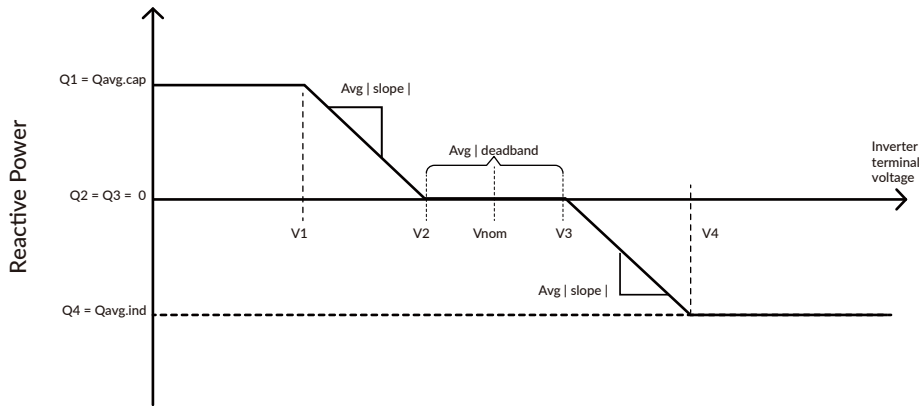

Parameter Name	Default Value	Minimum Adjustable Range	Maximum Adjustable Range
Voltage-Reactive Power Mode	Disable	NA	NA
Vref	100%Vnom	95%Vnom	105%Vnom
Autonomous VRef adjustment Enable	Disable	NA	NA
Vref adjustment time constant	300s	300s	5000s
V2	Vref-2%Vnom	Vref-3%Vnom	100%Vnom
Q2	0	-60% of nameplate apparent power	60% of nameplate apparent power
V3	Vref+2%Vnom	100%Vnom	Vref+3%Vnom
Q3	0	-60% of nameplate apparent power	60% of nameplate apparent power
V1	Vref-8%Vnom	Vref-18%Vnom	V2-2%Vnom
Q1	44% of nameplate apparent power	-60% of nameplate apparent power	60% of nameplate apparent power
V4	Vref+8%Vnom	Vref+18%Vnom	V3+2%Vnom
Q4	44% of nameplate apparent power	-60% of nameplate apparent power	60% of nameplate apparent power
Open Loop Response Time	5s	1s	90s

13.2.6 Active Power-Reactive Power Mode (Q(P))

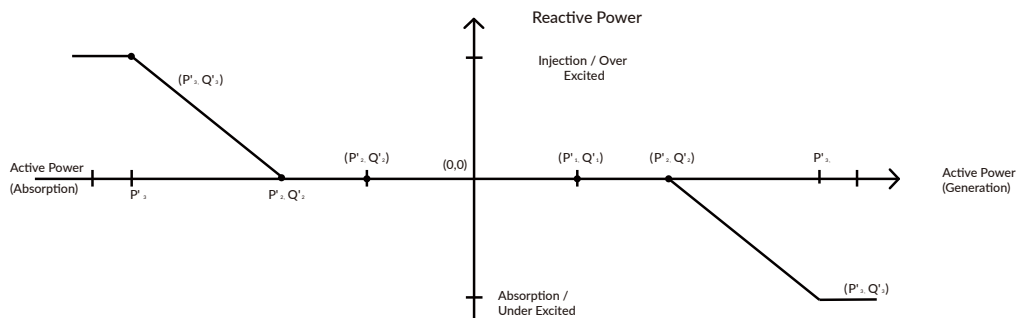

Parameter Name	Default Value	Minimum Adjustable Range	Maximum Adjustable Range
Active Power-Reactive Power Mode	Disable	NA	NA
P3	100%Pn	P2+10%Pn	100%Pn
P2	50%Pn	40%Pn	80%Pn
P1	0%Pn	0%Pn	P2-10%Pn
Q1	0	-60% of nameplate apparent power	60% of nameplate apparent power
Q2	0		
Q3	44% of nameplate apparent power		

Note:

P1, P2, P3 and P1', P1', P1' are Y-axis symmetrical relationship, Q1, Q2, Q3 and Q1', Q2', Q3' are X-axis symmetrical relationship, no need to set P1', P1', P1', Q1', Q2', Q3'.

13.2.7 Constant Reactive Power Mode

Parameter Name	Default Value	Minimum Adjustable Range	Maximum Adjustable Range
Constant Reactive Power Mode	Disable	NA	NA
Under-excited/ Over-excited	Under-excited	Under-excited	Over-excited
Constant Reactive Power	44% of nameplate apparent power	0	60% of nameplate apparent power

13.2.8 Frequency-Watt (FW)

Note:

Use the selected method to set Under-excited/Over-excited

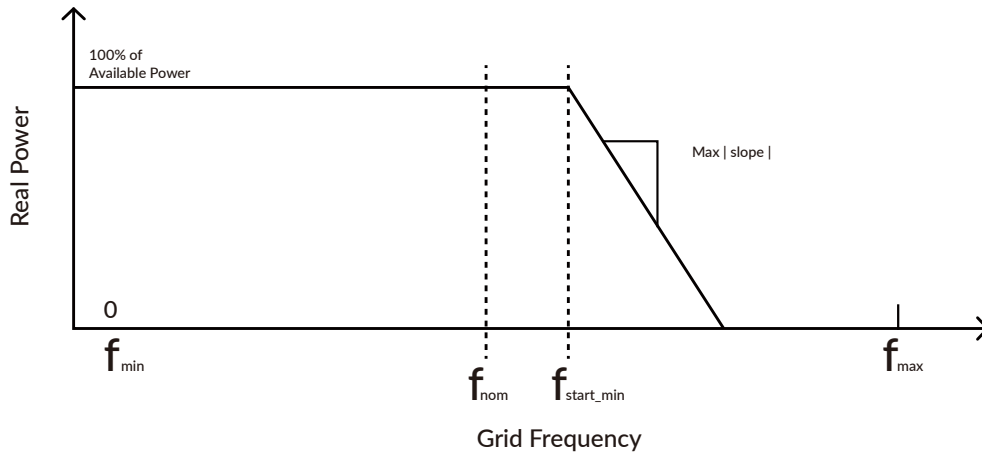

Parameter Name	Default Value	Minimum Adjustable Range	Maximum Adjustable Range
Frequency-Active Power Mode	Disable	NA	NA
Over frequency Droop dbOF	0.036Hz	0.017Hz	1Hz
Under frequency Droop dbUF	0.036Hz	0.017Hz	1Hz
Over frequency Droop kOF	0.05	0.02	0.07 (for HECO)
Under frequency Droop kUF	0.05	0.02	0.07 (for HECO)
Open Loop Response Time	0	200ms	10s

Note:

When setting the protection time, it needs to be converted into the number of cycles of the corresponding frequency.

13.2.9 Voltage-Watt (VW)

When the grid voltage exceeds V1, the output active power varies with the grid voltage.

Parameter Name	Default Value	Minimum Adjustable Range	Maximum Adjustable Range
Voltage-Active Power Mode	Disable	NA	NA
V1	106%Vnom	105%Vnom	109%Vnom
P1	Ppre-disturbance (for active power output at the time voltage exceeds V1 in p.u. of Prated)	NA	NA
V2	1.1*Un	1.04*Vn	1.10*Vn
P2	Pmin (for Advanced Inverters that can only inject active power, Pmin should approach 0)	NA	NA
Open Loop Response Time	10s	0.5s	60s

Note:

When setting the protection time, it needs to be converted into the number of cycles of the corresponding frequency.

13.2.10 Active power limit mode

Parameter Name	Default Value	Minimum Adjustable Range	Maximum Adjustable Range
Active power limit mode	Enable	NA	NA
Maximum Active Power(%)	100	0	100

13.3 Test Parameter Tolerances

We recommend checking and cleaning the fan every 6 months. If the fan is problematic, replace it as illustrated below. Shut down all systems and wait 5 minutes before dismantling the inverter.

Parameter	Units	Default Tolerance of Measurement
Voltage	Volts	±1%Urated
Current	Amps	±1%Urated
Power	Watts	±1%Urated
Reactive Power	VA	±5%Srated
Power Factor	Displacement power factor	±0.01
Frequency	Hz	±0.05
Response Time	Seconds	1
Time accuracy	Total time	0.10%

 MANGO POWER



Please scan this QR code for
more product information